

**OPERATION MANUAL**  
FOR  
DIAGNOSTIC ULTRASOUND SYSTEM  
***Aplio 500***  
MODEL TUS-A500  
[FUNDAMENTALS]  
(2B771-004EN\*M)

**CAUTION:**

In the USA, federal law restricts this device to sale by or on the order of a physician.

**IMPORTANT!**

Read and understand this manual before operating the equipment. After reading, keep this manual in an easily accessible place.

**TOSHIBA MEDICAL SYSTEMS CORPORATION**

# Introduction

This operation manual describes the operating procedures for the diagnostic ultrasound system TUS-A500. To ensure safe and correct operation of the system, carefully read and understand the manual before operating the system.

## Trademarks

Windows® is a registered trademark of Microsoft Corporation in the United States and other countries.

Clorox Healthcare™ is a trademark of The Clorox Company.

Dispatch® is a registered trademark of The Clorox Company.

Cleanisept® is a registered trademark of Dr. Schumacher GmbH.

Java is a registered trademark of Oracle and/or its affiliates.

APLIO, Dynamic Flow, ApliPure, MicroPure, and TwinView are trademarks of Toshiba Medical Systems Corporation.

This manual may include trademarks or registered trademarks of other companies.

Note that the trademark symbol "™" and the registered trademark symbol "®" may or may not be used in this manual.

### **IMPORTANT!**

1. No part of this manual may be copied or reprinted, in whole or in part, without prior written permission.
2. The contents of this manual are subject to change without prior notice and without legal obligation.
3. The contents of this manual are correct to the best of our knowledge. Please inform us of any ambiguous or erroneous descriptions, missing information, etc.

# Organization of the Operation Manuals

## 1. Notation Conventions

In this operation manual, the following word is used in addition to the signal words related to the safety precautions (refer to section 2 "General Safety Information"). Please read this operation manual before using the system.

**NOTE:** Indicates reference information that enables more efficient use of the equipment.

## 2. Operation Manuals

A TOSHIBA service person or instructor will explain the basic operating procedures for this system at the time of delivery. However, read this operation manual carefully before using the system in order to understand the detailed operating procedures, functions, performance, and maintenance procedures.

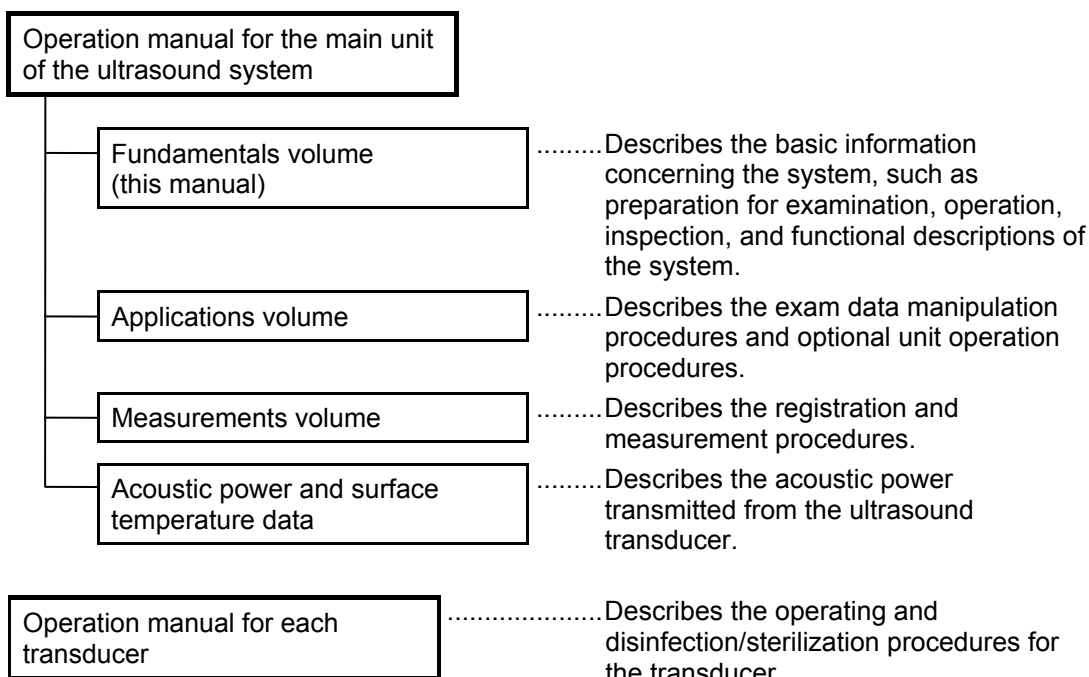

**NOTE:** For certain applications, the following manuals are available in English:

- 2B771-005EN Applications volume
- 2B771-006EN Measurements volume
- 2B771-007EN Acoustic power and surface temperature data (For regions other than the USA)
- 2B771-008EN Acoustic power and surface temperature data (For the USA only)
- 2B771-010EN Operation card

**NOTE:** The operation manuals Applications volume and Measurements volume may be supplied on electronic media.

### **3. Switch Configuration**

- The descriptions in this operation manual are based on the standard switch configuration. If the switch configuration has been changed, the differences between the current configuration and the standard configuration must be understood before use.
- The layout, shapes, labels, and icons of the switches on the touch panel can be changed. All the figures of touch panel and switches in this manual are examples and may differ from the actual display.

### **4. Operation Switches**

- Some operations can be performed using either the switches on the main panel or the corresponding switches on the touch panel.
- The switches displayed on the touch panel differ depending on the selected exam type, transducer, and mode.

# Table of Contents

Organization of the Operation Manuals.....	U-1
<b>1. Intended Use .....</b>	<b>1-1</b>
1.1 Intended Medical Use .....	1-1
1.2 Intended Patient Information.....	1-1
1.3 User Profile.....	1-1
1.4 Operating Principles.....	1-1
<b>2. General Safety Information .....</b>	<b>2-1</b>
2.1 Meaning of Signal Words.....	2-1
2.2 Meaning of Safety Symbols .....	2-1
2.3 Ensuring the Safety of Patients and Operators .....	2-2
2.4 Preventing Electric Shocks, Fires, and Power Supply Interruptions .....	2-3
2.5 Chemical Hazard .....	2-5
2.6 Electromagnetic Compatibility (EMC).....	2-5
2.7 Acoustic Power .....	2-6
2.8 Preventing System Malfunctions .....	2-7
2.9 Handling Patient and Image Data.....	2-9
2.10 Warning Labels .....	2-9
2.11 Regulatory Labels .....	2-12
2.12 Precautions Concerning Clinical Examination Techniques.....	2-13

<b>3.</b>	<b>General Information on Usage and Maintenance</b> .....	3-1
<b>4.</b>	<b>Use Conditions</b> .....	4-1
4.1	Power and Environmental Requirements .....	4-1
4.2	Environmentally Friendly Usage and Maintenance Management .....	4-2
<b>5.</b>	<b>System Configuration</b> .....	5-1
5.1	Standard Configuration.....	5-1
5.2	List of Optional Units .....	5-1
5.3	Compatible Peripheral Devices .....	5-2
5.4	External Storage Devices .....	5-2
5.5	List of Optional Software .....	5-3
5.6	List of Available Transducers.....	5-4
<b>6.</b>	<b>Names and Functions of Each Section</b> .....	6-1
6.1	Name of Each Section .....	6-1
6.2	Main Panel .....	6-3
6.3	Rear Panel.....	6-7
6.4	Symbols.....	6-8
<b>7.</b>	<b>Preparation for Examination</b> .....	7-1
7.1	Moving and Installing the System .....	7-1
7.2	Handling and Connecting/Disconnecting the Transducer .....	7-4
7.2.1	Handling the transducer .....	7-4

7.2.2	Connecting/Disconnecting the transducer .....	7-4
7.3	Adjusting the Main Panel .....	7-6
7.4	Adjusting the Monitor .....	7-8
7.4.1	Locking and releasing the monitor .....	7-8
7.4.2	Adjusting the angle of the monitor .....	7-9
7.4.3	Adjusting the monitor display .....	7-10
<b>8.</b>	<b>Checks Before and After Use .....</b>	<b>8-1</b>
8.1	Checks Before Turning ON the Power .....	8-1
8.2	Checks After Turning ON the Power .....	8-2
<b>9.</b>	<b>Turning the Power ON/OFF .....</b>	<b>9-1</b>
9.1	Connecting the Power Cable and the Protective Grounding .....	9-2
9.2	Turning ON the Power .....	9-4
9.3	Turning the Power OFF .....	9-6
9.4	Standby Mode .....	9-9
9.4.1	Setting Standby mode .....	9-9
9.4.2	Recovery from the Standby status .....	9-11
9.5	Preparation for Use During Surgery or for Emergency Cases .....	9-12
9.5.1	Preparation of a backup system .....	9-12
9.5.2	Power OFF/ON in the case of system failure .....	9-12
<b>10.</b>	<b>Basic Screen and Menu .....</b>	<b>10-1</b>
10.1	Display of Various Data Items .....	10-1
10.2	Displaying the Acoustic Power Data .....	10-2

10.3	Thumbnail Display .....	10-4
<b>11.</b>	<b>Starting an Examination .....</b>	<b>11-1</b>
11.1	Entering and Saving Data on the [Patient Registration] Screen .....	11-2
<b>12.</b>	<b>Reference Signal Display .....</b>	<b>12-1</b>
12.1	Reference Signal Panel .....	12-4
12.2	Installing the Reference Signal Sensor .....	12-5
12.3	Adjusting Reference Signals .....	12-5
<b>13.</b>	<b>Common Operation for Each Mode .....</b>	<b>13-1</b>
13.1	Touch Panel Operation .....	13-1
13.2	Trackball Functions .....	13-8
13.2.1	Trackball function area .....	13-8
13.2.2	Trackball operations .....	13-9
13.3	Selecting an Imaging Preset During Examination .....	13-10
13.3.1	[DEFAULT PRESET] tab .....	13-12
13.3.2	[USER PRESET] tab .....	13-15
13.3.3	[Sub Preset] menu .....	13-15
13.4	Selecting an Application Preset During Examination .....	13-16
13.5	Changing the Transducer During Examination .....	13-18
<b>14.</b>	<b>Display and Operation in Each Mode .....</b>	<b>14-1</b>
14.1	2D Mode .....	14-1
14.1.1	2D display layout .....	14-1



14.1.2	Adjustment using the main panel .....	14-2
14.1.3	Adjustments using the touch panel .....	14-5
14.1.4	Selection of image zooming method .....	14-8
14.1.5	2D mode quick scan .....	14-10
14.1.6	Trapezoid scan .....	14-12
14.2	<b>M Mode</b> .....	14-13
14.2.1	M display layout .....	14-13
14.2.2	Adjustment using the main panel .....	14-14
14.2.3	Adjustment using the touch panel .....	14-16
14.2.4	FLEX-M mode .....	14-18
14.3	<b>CDI Mode</b> .....	14-20
14.3.1	CDI display layout .....	14-20
14.3.2	Adjustment using the main panel .....	14-21
14.3.3	Adjustment using the touch panel .....	14-23
14.4	<b>Power Angio Mode (Power Mode)</b> .....	14-25
14.4.1	Power Angio display layout .....	14-25
14.4.2	Adjustment using the main panel .....	14-25
14.4.3	Adjustment using the touch panel .....	14-26
14.5	<b>Dynamic Flow Mode (ADF Mode)</b> .....	14-28
14.5.1	Dynamic Flow display layout .....	14-28
14.5.2	Adjustment using the main panel .....	14-28
14.5.3	Adjustment using the touch panel .....	14-29
14.6	<b>TDI Mode (Tissue Doppler Imaging Mode)</b> .....	14-31
14.6.1	TDI display layout .....	14-31
14.6.2	Adjustment using the main panel .....	14-31
14.6.3	Adjustment using the touch panel .....	14-32

<b>14.7</b>	<b>Doppler Mode</b> .....	14-34
14.7.1	Doppler display layout.....	14-34
14.7.2	Adjustment using the main panel .....	14-35
14.7.3	Adjustments using the touch panel .....	14-38
<b>15.</b>	<b>Cine Function</b> .....	15-1
15.1	Overview .....	15-1
15.2	Cine Operations .....	15-1
<b>16.</b>	<b>Body Mark</b> .....	16-1
16.1	Body Mark Entry Mode .....	16-1
16.2	Setting and Editing Body Marks .....	16-2
<b>17.</b>	<b>Entering Comments</b> .....	17-1
17.1	Entering Comment Entry Mode .....	17-1
17.2	Entering/Editing Characters and Arrow Marks .....	17-1
<b>18.</b>	<b>Needle Mark</b> .....	18-1
18.1	Applicable Transducers and Biopsy Adapters .....	18-3
18.2	Needle Mark Display and Angle Change Procedures .....	18-5
18.2.1	Needle mark display .....	18-6
18.2.2	Needle mark angle change procedures .....	18-8
<b>19.</b>	<b>Storing Image Data</b> .....	19-1
19.1	Storing Still Images .....	19-1
19.1.1	Operations using the touch panel .....	19-1
19.2	Storing a Dynamic Image.....	19-2

19.2.1	Operations using the touch panel .....	19-3
19.2.2	Snapshot Clips .....	19-4
19.2.3	Cine Clips (storage of cine image data) .....	19-6
19.2.4	Setting of the storage format (for retrospective storage) .....	19-8
19.3	File Handling for Image Data .....	19-8
19.4	Displaying Saved Images .....	19-8
<b>20.</b>	<b>Maintenance</b> .....	<b>20-1</b>
20.1	Technical Descriptions .....	20-1
20.2	Outline of Preventive Maintenance .....	20-1
20.3	Preventive Maintenance Performed by the User .....	20-2
20.3.1	Cleaning the system .....	20-2
20.3.2	Disinfecting the system .....	20-8
20.3.3	Creating a backup copy of the system hard disk .....	20-10
20.3.4	[Maintenance] menu .....	20-10
20.3.5	Backing up the customer-specific data (Backup) .....	20-11
20.4	Preventive Maintenance Performed by Service Personnel .....	20-14
20.5	Periodically Replaced Parts and Consumable Parts .....	20-14
20.6	Checks During Storage .....	20-14
<b>21.</b>	<b>Disposal</b> .....	<b>21-1</b>
<b>22.</b>	<b>Checks Before the System Is Judged Defective</b> .....	<b>22-1</b>
<b>23.</b>	<b>Specifications</b> .....	<b>23-1</b>

<b>23.1</b>	<b>External Dimensions and Mass</b> .....	23-1
<b>23.2</b>	<b>Essential Performance of This System</b> .....	23-1
<b>23.3</b>	<b>Conformance Standards</b> .....	23-2
<b>23.4</b>	<b>Safety Classification</b> .....	23-3
<b>23.5</b>	<b>Accuracy of Measurement</b> .....	23-4
<b>24.</b>	<b>Using MI/TI</b> .....	24-1
<b>24.1</b>	<b>Using MI/TI (Outside the USA and Canada)</b> .....	24-1
<b>24.1.1</b>	<b>Basic knowledge of MI/TI</b> .....	24-1
<b>24.1.2</b>	<b>MI/TI display description</b> .....	24-3
<b>24.1.3</b>	<b>Parameters affecting the MI/TI values</b> .....	24-4
<b>24.1.4</b>	<b>Operating procedures for MI/TI</b> .....	24-5
<b>24.1.5</b>	<b>Output display</b> .....	24-6
<b>24.1.6</b>	<b>Reminder</b> .....	24-6
<b>24.1.7</b>	<b>Ultrasonic output power and acoustic output</b> .....	24-7
<b>24.1.8</b>	<b>References for MI/TI</b> .....	24-8
<b>24.2</b>	<b>Using MI/TI (in the USA and Canada)</b> .....	24-9
<b>24.2.1</b>	<b>Basic knowledge of MI/TI</b> .....	24-9
<b>24.2.2</b>	<b>MI/TI display description</b> .....	24-11
<b>24.2.3</b>	<b>Parameters affecting the MI/TI values</b> .....	24-12
<b>24.2.4</b>	<b>Operating procedures for MI/TI</b> .....	24-13
<b>24.2.5</b>	<b>Output display</b> .....	24-14
<b>24.2.6</b>	<b>Information contained in the system documentation</b> .....	24-15
<b>24.2.7</b>	<b>Measurement uncertainty and precision</b> .....	24-15
<b>24.2.8</b>	<b>Reminder</b> .....	24-15
<b>24.2.9</b>	<b>Ultrasonic output power and acoustic output</b> .....	24-16

<b>24.2.10</b>	<b>References for MI/TI.....</b>	<b>24-18</b>
<b>25.</b>	<b>Guidance and Manufacturer's Declaration.....</b>	<b>25-1</b>
<b>26.</b>	<b>Intellectual Property.....</b>	<b>26-1</b>
<b>26.1</b>	<b>Availability of This Software and Related Documents Is Restricted.....</b>	<b>26-1</b>
<b>26.2</b>	<b>Agreement for Microsoft Software.....</b>	<b>26-1</b>
<b>26.3</b>	<b>Others.....</b>	<b>26-9</b>
<b>27.</b>	<b>Indication of Year of Manufacture.....</b>	<b>27-1</b>

# 1. Intended Use

## 1.1 Intended Medical Use

- (1) The intended use of this system is to visualize structures, characteristics, and dynamic processes within the human body using ultrasound and to provide image information for diagnosis.
- (2) This system provides high-quality ultrasound images in all its modes: 4D mode, 2D mode, M mode, CDI (Color Doppler Imaging) mode (blood-flow imaging), and Doppler mode (blood-flow spectrum).
- (3) This system is a general-purpose diagnostic ultrasound imaging system that conforms to the standard for Real Time Display of Thermal and Mechanical Output Indices on Diagnostic Ultrasound Equipment (American Institute of Ultrasound in Medicine (AIUM), 1992). Note that transducers have their own characteristic applications. For the transducers that can be used with this system and their applications, refer to subsection 5.6 "List of Available Transducers".

## 1.2 Intended Patient Information

- Age, health condition: Not specified

However, do not use this system if it is judged that the patient will be exposed to hazard due to the patient's own condition.

## 1.3 User Profile

- Only physicians or legally qualified persons who have received appropriate training

Before using this system, it must be ensured that the user has received sufficient training.

## 1.4 Operating Principles

This system transmits ultrasound signals into the human body from a transducer and receives the reflected echoes from the human body using the same transducer. It then processes the received signals and displays them as images on a display screen (LCD monitor).

Gating signals are sent from the scan control circuit through the transmission delay circuit and are input to the reception circuit. The reception circuit then generates the transmission signals (electrical pulses) according to the gating signals.

These electrical pulses are applied to piezoelectric elements that convert the electrical signals into mechanical vibrations in the transducer. These mechanical vibrations, which are ultrasound signals, are then transmitted into the human body.

This system supports convex, sector, linear, and some other scanning techniques.

When the ultrasound signals transmitted into the human body encounter a substance with different acoustic characteristics, they are reflected and return to the transducer as echoes. Based on the time required for the ultrasound signals to return to the transducer, the distance between the transducer surface and the reflecting substance can be determined.

In 2D (B) mode imaging, the echo amplitudes are represented as brightness changes on the image display screen. Since the ultrasound beam attenuates in tissue, the degree of amplification required generally increases as depth increases. Regions of high reflection are displayed as brighter, while regions of low reflection appear darker.

An M-mode image (cross-sectional image) can be displayed together with a 2D-mode image on the same screen through time-sharing control, allowing the user to perform M-mode diagnosis while observing a 2D-mode image.

In color Doppler imaging, phase detection is performed in a receive signal processing circuit to obtain I and Q signals. These signals undergo frequency analysis with the correlational method in a color Doppler imaging circuit to produce the mean velocity, variance, and power information of the blood flow. These information items are assigned color signals and represented as real-time two-dimensional color Doppler images.

In Doppler imaging, the signals output from the receive signal processing board are frequency-analyzed by fast Fourier transform (FFT) in a Doppler circuit to produce velocity and power information. A Doppler image is then displayed, plotting velocity on the vertical axis, time on the horizontal axis, and representing power as brightness.

This system supports basic measurements including distance, time, angle, and trace, as well as combinations of some basic measurements. In addition, calculations based on the measurement values can be performed for each region (circulatory organ, OB, etc.) using widely accepted expressions. The calculation results can be displayed in values, tables, or graphs.



## 2. General Safety Information

This section describes the general precautions and details that must be observed when using this system. Precautions related to specific operations are described in the corresponding sections.



When using the system, be sure to also read the precautions in the operation manual Measurements volume and the operation manual Applications volume, respectively.

### 2.1 Meaning of Signal Words

In this operation manual, the signal words **DANGER**, **WARNING**, and **CAUTION** are used regarding safety and other important instructions. The signal words and their meanings are defined as follows. Please understand their meanings clearly before reading this manual.

Signal word	Meaning
 <b>DANGER</b>	Indicates an imminently hazardous situation which, if not avoided, will result in death or serious injury.
 <b>WARNING</b>	Indicates a potentially hazardous situation which, if not avoided, could result in death or serious injury.
 <b>CAUTION</b>	Indicates a potentially hazardous situation which, if not avoided, may result in minor or moderate injury.
<b>CAUTION</b>	Indicates a potentially hazardous situation which, if not avoided, may result in property damage.

### 2.2 Meaning of Safety Symbols

Symbol	Description
	Type-B applied part * Type B when Type-B applied parts are connected. The heart sound sensor and pulse wave sensor that can be connected to this system are Type-B applied parts.
	Type-BF applied part * Type BF when Type-BF applied part is connected. The reference signal cables that can be connected to this system are Type-BF applied parts.
	"Attention" (Refer to the operation manual.)



## 2.3 Ensuring the Safety of Patients and Operators

Observe the following safety precautions to ensure the safety of patients and operators.

**⚠ DANGER:** This system must be used only when the potential benefits to the patient are judged outweigh the possible risk to the patient.

**⚠ WARNING:**

1. Do not use damaged or defective transducers. Doing so may result in injury to the patient.
2. Take special precautions when examining a patient with high temperature. A high patient temperature may slow down cooling of the transducer surface, which may result in a burn injury to the patient.  
  
If the surface temperature of the transducer becomes abnormally high, stop using the transducer and contact your TOSHIBA service representative.
3. This device is contraindicated for ophthalmic use or any application that causes the acoustic beam to pass through the eye.
4. Do not look inside the DVD/CD unit. The emitted laser beam is hazardous to the eyes and other parts of the body.
5. Prolonged and repeated use of keyboards can result in hand or arm nerve disorders in some individuals. Observe the local institutional work safety/health regulations on keyboard use.
6. Do not use the Fusion function (option) for patients who use electronic life-support devices (for example, a cardiac pacemaker or defibrillator). The magnetic field generated in Fusion mode may affect such devices.

**⚠ CAUTION:**

1. Do not use the transducer on the same region of the patient for a prolonged period. Low temperature burns may occur. Use the transducer for the minimum period of time that is required for diagnosis. Though the transducer surface temperature may exceed the patient's body temperature under some ambient conditions and usage modes, the use of the transducer for normal ultrasound diagnosis is unlikely to cause low temperature burns.
2. Do not sit on the system. Doing so may result in the system moving unexpectedly, causing you to lose your balance and fall.
3. When this system is used to examine an elderly patient or an infant, an attendant should be present if required.



## 2.4 Preventing Electric Shocks, Fires, and Power Supply Interruptions

Observe the following safety precautions to prevent electric shocks, fires, and power supply interruptions.

**⚠ DANGER:** Never use flammable or explosive gases near this system. Also do not use the system with oxygen or in an oxygen-enriched atmosphere. Doing so may result in an explosion (the system is not explosion-proof).

**⚠ WARNING:**

1. Follow the instructions below regarding the power cable and plug.
  - Insert the power plug only into a 3-pin (with protective grounding) medical electrical outlet.
  - Do not connect the power cable to a 2-pin outlet using an adapter.
  - Do not forcibly bend the cable.
  - Do not modify the power cable or plug.
  - Do not damage the power cable or plug.
  - Do not twist the power cable or plug.
  - Do not bundle the power cable or plug.
  - Do not place heavy objects on the power cable or plug.
  - Do not pinch the power cable or plug.
  - Do not subject the power cable or plug to impact.
  - Do not pull the power cable to disconnect the plug from the outlet.
2. If any abnormalities (such as damage or wear) are found on the power cable or plug, the power cable and plug must be replaced. Stop using it immediately and contact your Toshiba service representative. Continuing to use the system may result in electric shock, fire, or interruption of power supply.
3. Do not use the system if the connection to the outlet is loose.
4. If an abnormal smell or noise, or smoke occurs, immediately turn the main power switch on the power panel OFF and disconnect the plug from the power outlet. Continuing to use the system with such an abnormality may result in a fire etc. When using the system, ensure that there is enough space for access to the main power switch.
5. Do not allow this system or other equipment to come into contact with the patient. If this system or other equipment is defective, the patient may receive an electric shock.

- ⚠ WARNING:**
6. Do not connect any devices other than those specified by TOSHIBA to the USB connector or other connectors on the system.
  7. Do not connect to the system transducers other than those specified by TOSHIBA, to prevent accidents such as fire.
  8. Do not use a defective transducer.
  9. Do not remove the covers or panels of the system. Doing so exposes high-voltage parts.
  10. When in the patient environment, the operator must not touch any exposed connectors. In addition, if the system covers have been removed for some reason, the operator must be extremely careful not to touch any part where the voltage exceeds 25 VAC or 60 VDC and the patient at the same time. Doing so may result in an electric shock.
  11. Connect the equipotential terminal (  ) of this system to the equipotential bus of the facility using an equipotential conductor. When this system is used close to a device that is applied directly to the patient heart (such as in a cardiac catheterization room, CCU, or ICU), voltage equalization with the device is required to prevent an electric shock to the patient.
  12. A functional ground terminal (  ) is used to connect a functional grounding wire between systems or between the system and the ground for functional purposes of the system (for example, to eliminate potential differences in the signal level between systems or to eliminate potential differences between the system and the ground). Do not use the functional ground terminal for protective grounding. Also, do not connect the functional ground terminal to a gas pipe or water pipe. Doing so may result in the failure of functional grounding or in a gas explosion.
  13. Use a separate socket with an appropriate rated capacity for the supply of power to this system.
  14. Do not connect this system to an outlet that shares a circuit breaker (or fuse) with an outlet to which a device such as a life-support system is connected. If this system malfunctions and generates an overcurrent, or if there is a current surge when the power is turned ON, the circuit breaker may trip (or the fuse may blow).
  15. Do not connect the diagnostic ultrasound system to the same power outlet as another device. Doing so may cause the circuit breaker of the facility to trip, fuses to blow, or a fire or electric shock to occur.

**⚠️WARNING:** 16. Remove the ECG electrodes from the patient before using devices such as electric scalpels, high-frequency therapy equipment, electrostimulators, or electric defibrillators. In addition, when using such devices, do not let ultrasound transducers, PCG microphones, or pulse wave sensors to come into contact with the patient. Doing so may result in the patient receiving a burn injury or an electric shock.

**⚠️CAUTION:**

1. To prevent electric shock, do not connect peripheral units (such as a video printer or video recording unit) to an external outlet. Peripheral units should be connected inside the system. For the connection procedures, contact your TOSHIBA service representative.
2. If any abnormality of the system is found as a result of inspection, stop using the system and contact your TOSHIBA service representative for repair.
3. Do not spill or spray liquids such as water onto the system or peripheral units.

## 2.5 Chemical Hazard

Observe the following instruction in order to protect patients and operators from inflammation or poisoning by chemical substances.

**⚠️WARNING:** Handling the cord on this product will expose you to lead, a chemical known to the State of California to cause birth defects or other reproductive harm.  
*Wash hands after handling.*

## 2.6 Electromagnetic Compatibility (EMC)

Definition: Electromagnetic compatibility (EMC) refers to the ability to function without causing electromagnetic interference (EMI) in other devices or systems, as well as to a certain level of immunity to EMI from other devices or systems.

Observe the following precautions to ensure EMC.

**⚠️WARNING:** The use of transducers and cables other than those specified, with the exception of transducers and cables sold by Toshiba Medical Systems Corporation as replacement parts, may result in increased emissions or reduced system performance.

**⚠ CAUTION: Malfunctions due to radio waves**

- (1) This system may malfunction due to electromagnetic influence from electric scalpels, high-frequency therapy equipment, or other devices that generate high frequencies.
- (2) The use of radio-wave-emitting devices near this unit may interfere with its operation. Devices that generate radio waves, such as cellular phones, transceivers, and radio-controlled toys, must not be brought into the room where this unit is installed and must never be used near the unit.
- (3) If a device that generates radio waves is brought into the room where this unit is installed, instruct the user to turn OFF the power of the device immediately. This is necessary to ensure proper operation of the system.

- CAUTION:**
1. Do not use this system in locations exposed to strong electric or magnetic fields (near transformers, for example). Such fields may adversely affect the monitor.
  2. Do not use this system near devices that generate high frequencies (such as medical telemeters and cordless telephones). Doing so may cause the system to malfunction or to adversely affect such devices.
  3. Do not use devices that generate high frequencies near other devices or stack such devices on each other. If doing so is unavoidable, confirm that the system operates normally at its usual operating location.

## 2.7 Acoustic Power

Observe the following safety precautions.

- ⚠ CAUTION:**
1. When a fetus is to be exposed to ultrasound, set the acoustic power to as low a level as possible.
  2. The FDA allows ultrasound equipment to output acoustic power level TRACK3, which is higher than TRACK1, provided that MI/TI values are displayed on the system. This means that users now have a higher degree of responsibility for safety. Users are thus required to understand the bioeffects of ultrasound and their causes, and to only then increase diagnostic capabilities by increasing MI/TI. Refer to section 24 "Using MI/TI" for details.

## 2.8 Preventing System Malfunctions

Observe the following precautions to prevent system malfunctions.

- ⚠ CAUTION:**
1. Only software authorized by TOSHIBA should be installed in this system. Otherwise, a system failure or malfunction may result.
  2. If the system is infected with malware (malicious software, such as a computer virus or worm), data stored in the system may be deleted, altered, or disclosed or the system may malfunction or infect other systems. The user must establish security measures to prevent the system from being infected.
    - (a) Do not connect this system to a network for which any of the conditions below is true:
      - Security control is not established for the network.
      - There is a risk of malware invasion in the network.
      - A system for which any of the following conditions is true is connected to or can be connected to the network:
        - <1> The security of the system is not controlled by the user.
        - <2> The system can be accessed by persons not authorized by the user.
        - <3> The system is capable of wireless communication.
    - (b) The following instructions must be observed in order to prevent this system from being infected with malware:
      - Do not connect this system to the Internet.
      - When external storage media (such as a CD or USB flash drive) is to be used, confirm in advance that the media is not infected with malware.
      - Do not perform any other actions that may result in infection.

- CAUTION:**
1. To prevent damage to the system, do not install it in a location where it may be exposed to the following:
    - Direct sunlight
    - Sudden temperature fluctuations
    - Excessive dust
    - Excessive shock or vibration
    - High temperatures
    - High humidity
    - Poor air circulation because the system air filter is blocked by a wall etc. (A space at least 10 cm wide and 20 cm deep is required.)
  2. Do not disconnect the power plug while the system is starting up. Doing so may cause the system to malfunction.
  3. If either of the following phenomena occurs, press and hold down  for 5 seconds or more to turn OFF the power of the system.
    - The startup screen is not displayed after waiting for 30 seconds.
    - The patient registration screen is not displayed after waiting for 10 minutes.

If the power is not turned ON after holding down  for 5 seconds or more, turn OFF the main power on the power panel. Do not turn OFF the power in this manner during normal operation. Doing so may cause the system to malfunction.
  4. Do not press or use force on the main panel. Doing so may damage the system.
  5. The service outlets on the main unit provide power for recommended external options only. Do not connect other devices to these outlets. Doing so may result in the outlet power capacity being exceeded and cause a system malfunction.
  6. The cooling fan must be cleaned at least once a year. If the cooling fan is clogged, the internal temperature will rise, shortening the service life of the system. For inspection and cleaning by service personnel, contact your TOSHIBA service representative.
  7. If the main power switch on the power panel or circuit protector trips, be sure to consult your TOSHIBA service representative. If the main power switch is turned ON again before the problem is corrected, the system or a connected device may sustain further damage.

## 2.9 Handling Patient and Image Data

To prevent incorrect diagnosis and reexaminations, observe the following precautions when handling data.

**⚠ CAUTION:** 1. Entering patient data

Before starting an examination for a new patient, confirm that the patient ID matches the patient to be examined. If images are recorded with an incorrect patient ID, the data may be mixed up with that for another patient, resulting in incorrect diagnosis.

2. This system is provided with a lossy data compression function for images. Although this function helps to reduce the size of stored images, it can cause image deterioration. The amount of compression must therefore be limited so that the image quality is maintained at a level that does not adversely affect image reading.

## 2.10 Warning Labels

Various warning labels are attached to this system in order to call the user's attention to potential hazards.

- \* The symbol **⚠** on the warning labels indicates safety precautions. Warning labels use the same signal words as used in the descriptions in the operation manuals. Read the operation manuals carefully before using the system.

The appearance and location of each warning label are as follows.



<<Warning labels on systems complying with the European Directive 93/42/EEC>>

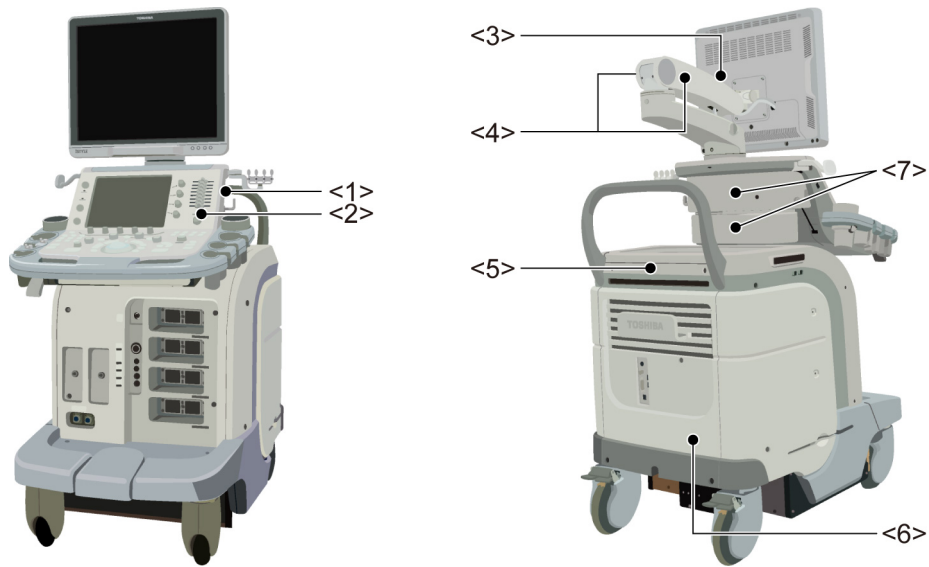

No.	Label	Meaning
<1>		Urges caution related to handling of the transducers. For handling of the transducers, refer to the transducers' operation manual.
<2>		Cautions that the MI/TI must be controlled as low as reasonably achievable.
<3>	   (a) (b) (c)	(a) Cautions that the system must be placed on a horizontal surface. (b) Cautions that the cover must not be removed in order to prevent electric shock. (c) Cautions that the system must not be leaned on nor pushed from the side.
<4>		Cautions regarding handling of the monitor arm.
<5>	  (a) (b)	(a) Cautions against sitting on the system. (b) Urges caution related to the switches on the main panel.
<6>	 	Cautions that the system must not be used around flammable gases.
<7>		Cautions that hands may be caught when the height of the main panel is adjusted.



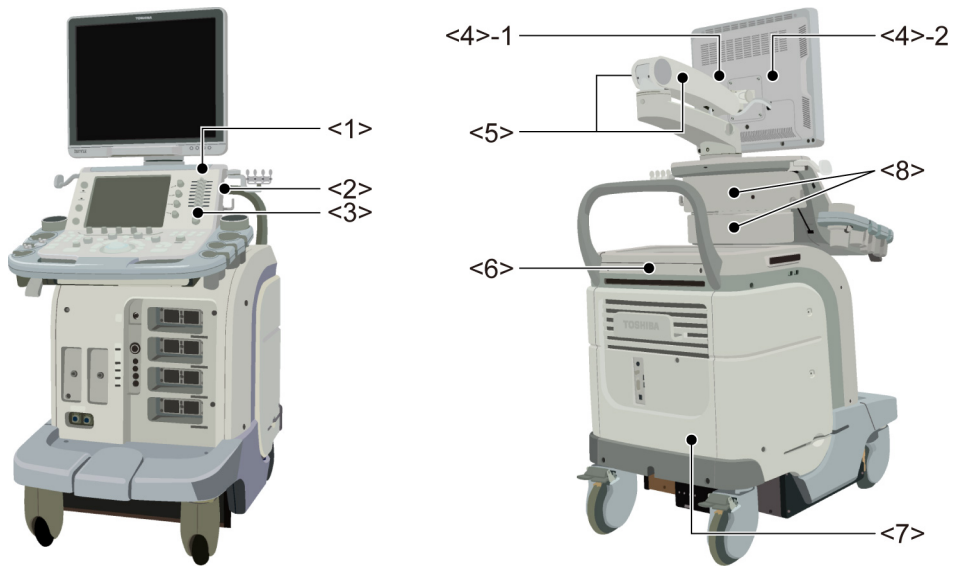

<<Warning labels on other systems>>

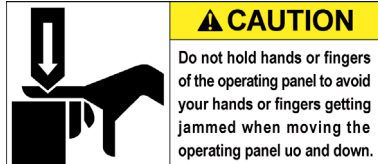

No.	Label	Meaning
<1>	<b>CAUTION</b> FEDERAL LAW RESTRICTS THIS DEVICE TO SALE BY OR ON THE ORDER OF A PHYSICIAN.	Cautions that restrict this device to sale by or on the order of a physician. (USA/Canada only)
<2>	<b>PROBE USE PRECAUTIONS</b> THE PROBE IS HIGHLY SENSITIVE TO SHOCK ; ALWAYS HANDLE CAREFULLY; REFER TO THE OPERATION MANUAL FOR HANDLING AND CLEANING INSTRUCTIONS.	Urges caution related to handling of the transducers.
<3>		(a) Cautions that the MI/TI must be controlled as low as reasonably achievable. (b) As in the USA and Canada, cautions that displayed MI/TI are mean values. Refer to subsection 24.2.2 "MI/TI display description".
<4>-1	 <b>CAUTION</b> Do not place the system on a sloped surface. The system may slide unexpectedly, resulting in crush injury. The system should be moved over a sloped surface by two persons to ensure safety.	Cautions that the system must be placed on a horizontal surface.
<4>-2	 <b>CAUTION</b> High voltages inside may cause electric shock. Only service engineers should remove covers.	Cautions that the cover must not be removed in order to prevent electric shock.
<5>	 <b>CAUTION</b> Do not place your hands on near this label. Your hands may get caught by the arm, resulting in injury.	Cautions regarding handling of the monitor arm.
<6>	 <b>CAUTION</b> Do not stand or sit on the system. The system may move, causing you to lose your balance and fall.  <b>CAUTION</b> The function of each switch can be reassigned. Please confirm the function of each switch before doing examination to avoid any confusion.	(a) Cautions against sitting or leaning on the system. (b) Urges caution related to the switches on the main panel.

No.	Label	Meaning
<7>		Cautions that the system must not be used around flammable gases.
<8>		Cautions that hands may be caught when the height of the main panel is adjusted.

<<Warning labels for options>>

Item	Label	Meaning
Fusion unit (UIFR-A500A)		Cautions that the Fusion function (option) must not be used for patients who use electronic life-support devices (for example, a cardiac pacemaker or defibrillator). The magnetic field generated in Fusion mode may affect such devices.
Fusion Pole Cart (UZWT-A500A)		Cautions that the operation manual must be referred to.
		Cautions that the Fusion pole cart must not be leaned on or pushed forcefully from the side.
M-TEE hanger kit (UAEH-770A)		Precautions related to handling
Motor drive M-TEE hanger kit (UAEH-002A)		<ol style="list-style-type: none"> <li>1. Place the transducer in the box for transportation.</li> <li>2. Do not allow the transducer to bump against the main unit.</li> </ol>

## 2.11 Regulatory Labels

Label	Meaning
	This label indicates this device complies with European Directive 93/42/EEC and subsequent amendments.

## **2.12 Precautions Concerning Clinical Examination Techniques**

- (1) This operation manual is intended for users who are well-versed in the principles and basic techniques of ultrasound.
- (2) This system must be used only by medical personnel fully trained in clinical examination techniques.
- (3) This operation manual does not describe clinical examination techniques. Selection of the proper clinical examination technique must be based on specialized training and clinical experience.

### 3. General Information on Usage and Maintenance

1. The responsibility for maintenance and management of the product after delivery resides with the customer who has purchased the product.
2. The warranty does not cover the following items, even during the warranty period:
  - (1) Damage or loss due to misuse or abuse.
  - (2) Damage or loss caused by Acts of God such as fires, earthquakes, floods, lightning, etc.
  - (3) Damage or loss caused by failure to meet the specified conditions for this system, such as inadequate power supply, improper installation, or unacceptable environmental conditions.
  - (4) Damage or loss due to mobile use in a vehicle which is not authorized by TOSHIBA.
  - (5) Damage or loss due to use outside the territory in which the system was originally sold.
  - (6) Damage or loss involving system purchased from a source other than TOSHIBA or its authorized distributors or agents.
3. This system shall not be used by persons other than fully qualified and certified medical personnel.
4. Do not make changes or modifications to the software or hardware of this product.
5. In no event shall TOSHIBA be liable for problems, damage, or loss caused by relocation, modification, or repair performed by personnel other than those designated by TOSHIBA.
6. The purpose of this system is to provide physicians with data for clinical diagnosis.  
The responsibility for diagnostic procedures lies with the physicians involved. TOSHIBA shall not be liable for the results of diagnostic procedures.
7. Important data must be backed up on external recording media such as clinical records, notebooks, floppy disks, or magnetic tapes.
8. TOSHIBA shall not be liable for loss of data stored in the memory of this system caused by operator error or accidents.
9. This manual contains warnings regarding foreseeable potential dangers. Be alert at all times to dangers other than those indicated.
10. TOSHIBA shall not be liable for damage or loss that results from negligence or from ignoring the precautions and operating instructions contained in this operation manual.
11. Ultrasound transducers are precision equipment and should be handled with proper care. If they are not handled according to the instructions in the operation manual, problems such as scratches, holes, defects in the acoustic lens surface, twisting of the transducer cable, or degradation of the ultrasound images may result.  
Note that the warranty does not cover problems caused by improper handling of the transducers.

12. TOSHIBA shall not be liable for any error or malfunction that results from use of a transducer other than that specified by TOSHIBA.
13. On the occasion of change of the administrator or manager for this system, be sure to hand over this operation manual.
14. When this system is to be transported, be sure to contact your TOSHIBA service representative first. Special packaging must be performed by a TOSHIBA service engineer or a service engineer authorized by TOSHIBA. TOSHIBA does not assume any responsibility for damage resulting from transportation of this system without consulting TOSHIBA.
15. When disposing of this system, contact your TOSHIBA service representative. Do not dispose of this system without consulting TOSHIBA service representative first. TOSHIBA does not assume any responsibility for damage resulting from disposal of this system without consulting TOSHIBA.

**NOTE:** Concerning the WEEE label

The following information is only for EU member states:

The use of this symbol indicates that this product should not be treated as household waste.

By ensuring that this product is disposed of correctly, you will help prevent potential negative consequences for the environment and human health, which could otherwise be caused by inappropriate waste-handling of this product.

For more detailed information concerning the return and recycling of this product, please consult the supplier from whom you purchased the product.

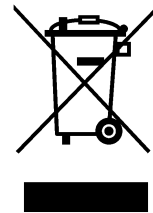

\* For system products, this label may be attached to the main unit only.

**NOTE:** Concerning BATTERIES

The following information is only for EEA countries:

The directive 2006/66/EC requires separate collection and appropriate disposal of spent batteries.

This product also contains batteries that are not intended to be replaced by the user.

Replacement of those batteries will usually be done during regular maintenance or service by service staff who can also arrange proper disposal.

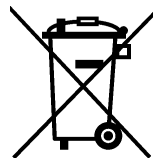

**NOTE:** Regulatory information

The high-efficiency LCD backlights used in this product contain 5 mg or less of mercury, the disposal of which may be regulated due to environmental considerations.

For disposal or recycling information, please contact your local authorities or the Electronic Industries Alliance ([www.eiae.org](http://www.eiae.org)).

This information is only for the USA.

**NOTE:** Perchlorate Material - special handling may apply.  
See <http://www.dtsc.ca.gov/hazardouswaste/perchlorate/>

This is applicable to California, USA, only.

16. This system shall be connected to a network only if security measures against malware infection have been established for the network.
17. Expected service life  
The expected service life is 7 years if the specified maintenance and inspection procedures are performed.  
However, the service life depends on usage conditions, and individually specified periods, if any, take precedence.
18. This manual provides information on minimizing the environmental impact (carbon dioxide emission, power consumption, etc.) of this system. Use the information appropriately according to the intended use of the system.

# 4. Use Conditions

## 4.1 Power and Environmental Requirements

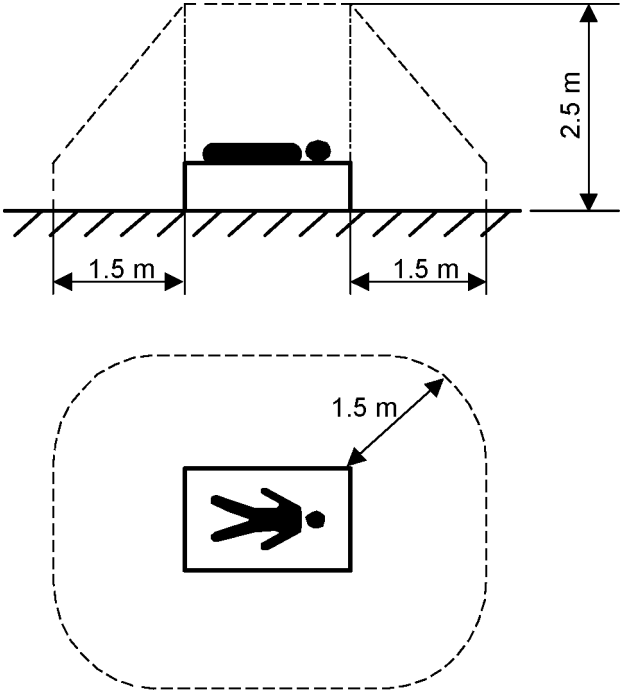
Item		Specifications
Power	Line voltage	USA 120 VAC $\pm$ 10% Europe 220 to 240 VAC $\pm$ 10% Other 1 110 to 120 VAC $\pm$ 10% Other 2 220 to 240 VAC $\pm$ 10%
	Line frequency	50 Hz to 60 Hz
	Power consumption	USA 1440 VA Europe 1500 VA Other 1 1440 VA Other 2 1500 VA
Operating environmental conditions	Ambient temperature	10°C to 35°C
	Relative humidity	35% to 80% (no condensation)
	Atmospheric pressure	700 hPa to 1060 hPa
Storage and transportation conditions	Ambient temperature	-10°C to 50°C
	Relative humidity	30% to 80% (no condensation) 50% or less if the ambient temperature exceeds 40°C
	Atmospheric pressure	700 hPa to 1060 hPa
Patient environment	<p>This system is designed to be used in the environment specified in the figure below.</p> 	



## 4.2 Environmentally Friendly Usage and Maintenance Management

Observe the following to keep environmental impact to a minimum.

- (1) Turn the system power OFF when the system is not in use.
- (2) When the system is not to be used for an extended period of time, turn OFF the main power switch on the power panel and disconnect the power plug from the outlet.
- (3) Freeze the image by pressing  whenever examination is not being performed.

# 5. System Configuration

## 5.1 Standard Configuration

- (1) Main unit of the system
- (2) Accessories
  - Operation manuals
  - Cables
  - Transducer holder
  - Gel holder

## 5.2 List of Optional Units

The following optional units are available with this system.

No.	Item	Model
1	CW unit	UICW-A500A
2	Reference signal unit	UJUR-A500A (Except for USA)
3	Reference signal unit	UJUR-A501A (Only for USA)
4	Reference signal sensor unit	UJUR-772A
5	Mounting kit for peripheral unit	UZRI-A500A
6	Mounting kit for peripheral unit	UZRI-A501A
7	Footswitch	UZFS-A500A
8	Gel warmer	UZGW-007A
9	M-TEE hanger kit	UAEH-770A
10	Motor drive M-TEE hanger kit	UAEH-002A
11	4D unit	UIMV-A500A
12	Battery kit	UEBT-A500A
13	HV power kit	UIHV-A500A
14	Fusion unit	UIFR-A500A
15	Fusion Pole Cart	UZWT-A500A
16	Mounting kit for fusion sensor*	UAFS-001A
17	Mounting kit for fusion sensor*	UAFS-002A
18	Mounting kit for fusion sensor*	UAFS-003A
19	Transducer cable hanger kit	UZMK-A500A
20	CV kit	UACV-A500A

\*: The mounting kit for fusion sensor is used in combination with the fusion unit UIFR-A500A.

### 5.3 Compatible Peripheral Devices

The following devices are available with this system.

No.	Item	Model
1	Black-and-white digital printer	UP-D897 (SONY) P95DW (MITSUBISHI)
2	Color digital printer	CP30DW (MITSUBISHI) UP-D25MD (SONY)
3	DVD video recorder	DVO-1000MD (NTSC/PAL: SONY) BD-X201M (NTSC/PAL: JVC, for regions other than Europe) BD-X201ME (PAL: JVC, for Europe)

\* It may not be possible to use some of the peripheral devices listed above depending on the power conditions of the country. For details, contact your TOSHIBA service representative.

### 5.4 External Storage Devices

USB flash drives and barcode readers can be connected to this system. Contact your TOSHIBA service representative for the recommended models.

## 5.5 List of Optional Software

The following optional software is available with this system.

No.	Item	Model
1	Realtime ASQ kit*	USAS-A500A, USAS-A500A/EL
2	Smart Fusion kit	USFN-A500A, USFN-A500A/EL
3	Fly Thru. kit	USFT-A500A, USFT-A500A/EL
4	Elastography kit	USEL-A500A, USEL-A500A/EL
5	2D Wall Motion Tracking kit	USWT-A500A, USWT-A500A/EL
6	MicroPure™ kit	USMP-A500A, USMP-A500A/EL
7	CHI-Q kit	USCQ-A500A, USCQ-A500A/EL
8	CHI kit	USHI-A500A, USHI-A500A/EL
9	Panoramic View kit	USPV-A500A, USPV-A500A/EL
10	4D STIC Imaging kit	USST-A500A, USST-A500A/EL
11	Stress Echo kit	USSE-A500A, USSE-A500A/EL
12	DICOM kit	USDI-A500A, USDI-A500A/EL
13	1.5D Transducer kit	USMS-A500A, USMS-A500A/EL
14	Protocol Assistant kit	USPA-A500A, USPA-A500A/EL
15	Parametric MFI kit*	USPM-A500A, USPM-A500A/EL
16	Vascularity Index kit	USVI-A500A, USVI-A500A/EL
17	FLR kit*	USFL-A500A, USFL-A500A/EL
18	Elastography-FLR kit*	USEL-A501A, USEL-A501A/EL
19	FLEX-M kit	USXM-A500A, USXM-A500A/EL
20	Luminance kit	USLM-A500A, USLM-A500A/EL
21	Superb Micro vascular Imaging kit	USMI-A500A, USMI-A500A/EL

\*: This option is not available in the USA.

**NOTE:** "/EL" is a supplemental model name indicating options supplied by electronic license.

## 5.6 List of Available Transducers

The following transducers are available with this system.

Transducer name	Principal use
PST-25BT	Cardiac, pediatric, abdominal, adult cephalic, neonatal cephalic
PST-30BT	Cardiac, abdominal, adult cephalic, neonatal cephalic
PST-50BT	Cardiac, pediatric, and neonatal cephalic
PST-65AT	Cardiac, neonatal cephalic, pediatric
PVT-350BTP <sup>*2</sup>	Abdominal
PVT-375BT	Abdominal, fetal, pediatric
PVT-375MV	Abdominal, fetal, pediatric
PVT-382BT	Abdominal, fetal, pediatric
PVT-382MV	Abdominal, fetal, pediatric
PVT-661VT	Transrectal, transvaginal
PVT-674BT	Abdominal, fetal
PVT-675MV	Fetal
PVT-681MV	Transvaginal, transrectal
PVT-712BT	Neonatal cephalic, abdominal
PVT-745BTF	Abdominal, small organs, intraoperative
PVT-745BTH	Abdominal, small organs, intraoperative
PVT-745BTV	Abdominal, small organs, intraoperative
PVT-770RT	Transrectal
PVT-781VT	Transrectal, transvaginal
PLT-308P <sup>*2</sup>	Abdominal
PLT-604AT	Peripheral vascular, small organ, musculoskeletal
PLT-704AT	Peripheral vascular, small organ, musculoskeletal
PLT-704SBT	Small organs, peripheral vascular, musculoskeletal
PLT-705BTF	Abdominal
PLT-705BTH	Abdominal
PLT-805AT	Peripheral vascular, small organs, musculoskeletal
PLT-1005BT	Peripheral vascular, small organs, musculoskeletal
PLT-1202S	Peripheral vascular, small organs, musculoskeletal, intraoperative
PLT-1204BT	Peripheral vascular, small organs, musculoskeletal
PLT-1204BX <sup>*1</sup>	Peripheral vascular, small organs, musculoskeletal
PLT-1204MV	Small organs, peripheral vascular, musculoskeletal
PET-508MA	Cardiac (transesophageal)
PET-510MA <sup>*3</sup>	Cardiac (transesophageal)
PET-510MB <sup>*4</sup>	Cardiac (transesophageal)
PET-511BTM <sup>*2</sup>	Cardiac (transesophageal)
PET-512MA <sup>*2</sup>	Cardiac (transesophageal)
PET-512MC	Cardiac (transesophageal)
PC-20M	Cardiac, pediatric
PC-50M	Cardiac, peripheral vascular, pediatric

\*1: When this transducer is used, optional unit UIHV-A500A and optional software USMS-A500A are required.

\*2: This transducer is not available in the USA and Canada.

\*3: This transducer is not available in the USA.

\*4: This transducer is available in the USA only.

Transducer name	2D mode			M mode	CDI mode	Power mode	Dynamic Flow mode	SMI <sup>*4</sup> mode	TDI mode	Elasto-graphy mode <sup>*4</sup>	PW mode	CW mode	CHI mode <sup>*4</sup>				Apli-Pure	Micro-Pure <sup>*4</sup>	Precision imaging /TE	ASQ <sup>*4</sup>
	Fund.	Pulse Subtract ON	Pulse Subtract OFF										2D	Dynamic Flow	MFI	VRI				
PST-25BT	○	○	○	○	○	○/x <sup>*1</sup>	○/x <sup>*1</sup>	x	○	x	○	○	○	x	○	x	x	x	○ <sup>*5</sup>	○
PST-30BT	○	○	○	○	○	○/x <sup>*1</sup>	○/x <sup>*1</sup>	x	○	x	○	○	○	x	○	x	x	x	○ <sup>*5</sup>	○
PST-50BT	○	○	○	○	○	○/x <sup>*1</sup>	○/x <sup>*1</sup>	x	○	x	○	○	x	x	x	x	x	x	○ <sup>*5</sup>	x
PST-65AT	○	○	○	○	○	○/x <sup>*1</sup>	○/x <sup>*1</sup>	x	○	x	○	○	○ <sup>*3</sup>	x	○ <sup>*3</sup>	x	x	x	○ <sup>*5</sup>	x
PVT-350BTP	○	○	○ <sup>*2</sup>	○	○	○	○	x	x	x	○	x	○ <sup>*3</sup>	○ <sup>*3</sup>	○ <sup>*3</sup>	○ <sup>*3</sup>	○	x	○	○
PVT-375BT	○	○	○ <sup>*2</sup>	○	○	○	○	○	○	○	○	x	○	○	○	○	○	x	○	○
PVT-375MV	○	○	○ <sup>*2</sup>	○	○	○	○	x	x	x	○	x	○ <sup>*3</sup>	○ <sup>*3</sup>	○ <sup>*3</sup>	○ <sup>*3</sup>	○	x	○	○
PVT-382BT	○	○	○ <sup>*2</sup>	○	○	○	○	x	x	x	○	x	○ <sup>*3</sup>	○ <sup>*3</sup>	○ <sup>*3</sup>	○ <sup>*3</sup>	○	x	○	x
PVT-382MV	○	○	○ <sup>*2</sup>	○	○	○	○	x	x	x	○	x	○ <sup>*3</sup>	○ <sup>*3</sup>	○ <sup>*3</sup>	○ <sup>*3</sup>	○	x	○	x
PVT-661VT	○	○	○ <sup>*2</sup>	○	○	○	○	x	○	○	○	x	○ <sup>*3</sup>	○ <sup>*3</sup>	○ <sup>*3</sup>	○ <sup>*3</sup>	○	x	○	○
PVT-674BT	○	○	○ <sup>*2</sup>	○	○	○	○	x	x	x	○	x	○ <sup>*3</sup>	x	○ <sup>*3</sup>	x	○	x	○	○
PVT-675MV	○	○	○ <sup>*2</sup>	○	○	○	○	x	x	x	○	x	x	x	x	x	○	x	○	○
PVT-681MV	○	○	○ <sup>*2</sup>	○	○	○	○	x	○	○	○	x	○	x	○	x	○	x	○	x
PVT-712BT	○	○	○ <sup>*2</sup>	○	○	○	○	x	x	x	○	x	x	x	x	x	○	x	○	x
PVT-745BTF	○	○	○ <sup>*2</sup>	○	○	○	○	x	x	x	○	x	○ <sup>*3</sup>	x	○ <sup>*3</sup>	x	○	x	○	x
PVT-745BTH	○	○	○ <sup>*2</sup>	○	○	○	○	x	x	x	○	x	○ <sup>*3</sup>	x	○ <sup>*3</sup>	x	○	x	○	x
PVT-745BTV	○	○	○ <sup>*2</sup>	○	○	○	○	x	x	x	○	x	x	x	x	x	○	x	○	x
PVT-770RT	○	○	○ <sup>*2</sup>	○	○	○	○	x	x	x	○	x	x	x	x	x	○	x	○	x
PVT-781VT	○	○	○	○	○	○	○	x	○	○	○	x	○ <sup>*3</sup>	x	x	○ <sup>*3</sup>	○	x	○	x
PLT-308P	○	○	x	○	○	○	○	x	x	x	○	x	x	x	x	x	○	x	○	x
PLT-604AT	○	○	○ <sup>*2</sup>	○	○	○	○	x	x	x	○	x	○ <sup>*3</sup>	○ <sup>*3</sup>	○ <sup>*3</sup>	○ <sup>*3</sup>	○	x	○	x
PLT-704AT	○	○	○ <sup>*2</sup>	○	○	○	○	x	x	x	○	x	○ <sup>*3</sup>	○ <sup>*3</sup>	○ <sup>*3</sup>	x	○	x	○	○
PLT-704SBT	○	○	○ <sup>*2</sup>	○	○	○	○	○	x	x	○	x	○ <sup>*3</sup>	○ <sup>*3</sup>	○ <sup>*3</sup>	x	○	x	○	○
PLT-705BTF	○	○	○ <sup>*2</sup>	○	○	○	○	x	x	x	○	x	○ <sup>*3</sup>	x	○ <sup>*3</sup>	x	○	x	○	x
PLT-705BTH	○	○	○ <sup>*2</sup>	○	○	○	○	x	x	x	○	x	○ <sup>*3</sup>	x	○ <sup>*3</sup>	x	○	x	○	x
PLT-805AT	○	○	○ <sup>*2</sup>	○	○	○	○	x	○	○	○	x	○ <sup>*3</sup>	○ <sup>*3</sup>	○ <sup>*3</sup>	○ <sup>*3</sup>	○	○	○	○
PLT-1005BT	○	○	○	○	○	○	○	○	○	○	○	x	○	○	○	○	○	○	○	○
PLT-1202S	○	○	x	○	○	○	○	x	○	○	○	x	○ <sup>*3</sup>	x	○ <sup>*3</sup>	x	○	x	○	x
PLT-1204BT	○	○	○ <sup>*2</sup>	○	○	○	○	○	○	○	○	x	○ <sup>*3</sup>	x	○ <sup>*3</sup>	x	○	○	○	○

○ : Available x : Not available

Transducer name	2D mode			M mode	CDI mode	Power mode	Dynamic Flow mode	SMI <sup>*4</sup> mode	TDI mode	Elasto-graphy mode <sup>*4</sup>	PW mode	CW mode	CHI mode <sup>*4</sup>				Apli-Pure	Micro-Pure <sup>*4</sup>	Precision imaging /TE	ASQ <sup>*4</sup>
	Fund.	Pulse Subtract ON	Pulse Subtract OFF										2D	Dynamic Flow	MFI	VRI				
PLT-1204BX	○	○	○ <sup>*2</sup>	○	○	○	○	×	○	○	○	×	×	×	×	×	○	×	○	○
PLT-1204MV	○	○	○ <sup>*2</sup>	○	○	○	○	×	×	×	○	×	○ <sup>*3</sup>	×	○ <sup>*3</sup>	×	○	×	○	○
PET-508MA	○	○	○	○	○	×	×	×	○	×	○	○	×	×	×	×	×	×	○ <sup>*5</sup>	×
PET-510MA/MB	○	○	○	○	○	×	×	×	○	×	○	○	×	×	×	×	×	×	○ <sup>*5</sup>	×
PET-511BTM	○	○	○	○	○	×	×	×	○	×	○	○	×	×	×	×	×	×	○ <sup>*5</sup>	×
PET-512MA	○	○	○	○	○	×	×	×	○	×	○	○	×	×	×	×	×	×	○ <sup>*5</sup>	×
PET-512MC	○	○	○	○	○	×	×	×	○	×	○	○	×	×	×	×	×	×	○ <sup>*5</sup>	×
PC-20M	×	×	×	×	×	×	×	×	×	×	×	○	×	×	×	×	×	×	×	×
PC-50M	×	×	×	×	×	×	×	×	×	×	×	○	×	×	×	×	×	×	×	×

○ : Available × : Not available

Transducer name	4D Live mode <sup>*4</sup>			Single Sweep mode <sup>*4</sup>			4D CHI <sup>*4</sup>	STIC <sup>*4</sup>	STIC color <sup>*4</sup>	Volume color <sup>*4</sup>	4D Biopsy <sup>*4</sup>	FlyThru <sup>*4</sup>
	Fund.	Pulse Subtract ON	Pulse Subtract OFF	Fund.	Pulse Subtract ON	Pulse Subtract OFF						
PVT-375MV	○	×	○	○	○	○ <sup>*2</sup>	○ <sup>*3</sup>	○/x <sup>*1</sup>	○/x <sup>*1</sup>	○	○	○
PVT-382MV	○	×	○	○	○	○ <sup>*2</sup>	○ <sup>*3</sup>	×	×	○	○	○
PVT-675MV	○	×	○	○	○	○ <sup>*2</sup>	×	○/x <sup>*1</sup>	○/x <sup>*1</sup>	○	×	○
PVT-681MV	○	×	×	○	○	○ <sup>*2</sup>	○ <sup>*3</sup>	×	×	○	○	○
PLT-1204MV	○	×	×	○	○	○ <sup>*2</sup>	○ <sup>*3</sup>	×	×	○	○	○

○ : Available × : Not available

\*1) Depends on the preset.

\*2) Differential THI

\*3) Not available in the USA.

\*4) Optional software is required.

\*5) TE

# 6. Names and Functions of Each Section

## 6.1 Name of Each Section

- Systems with the main power switch on the rear

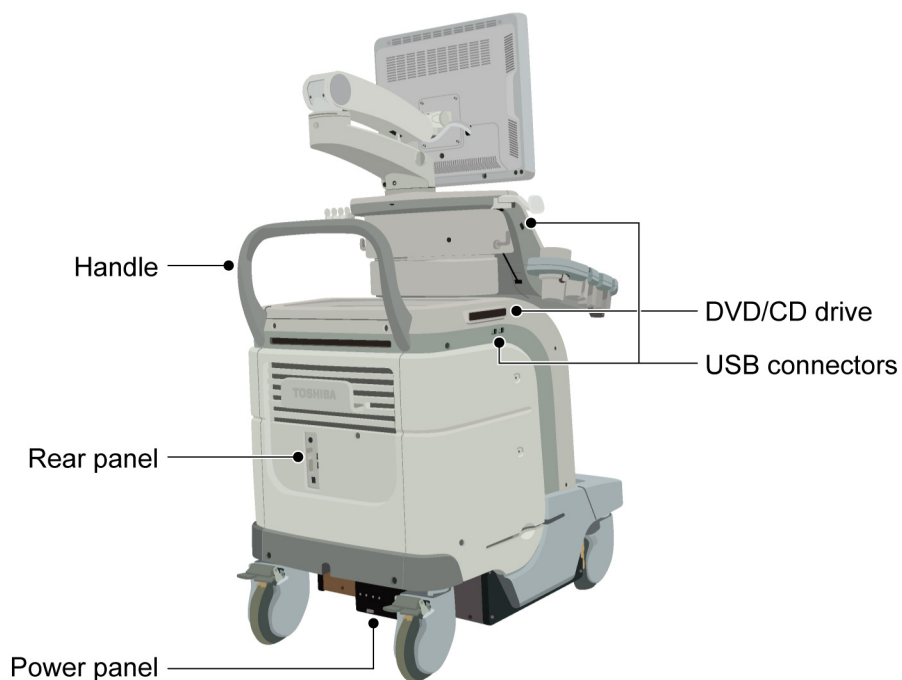
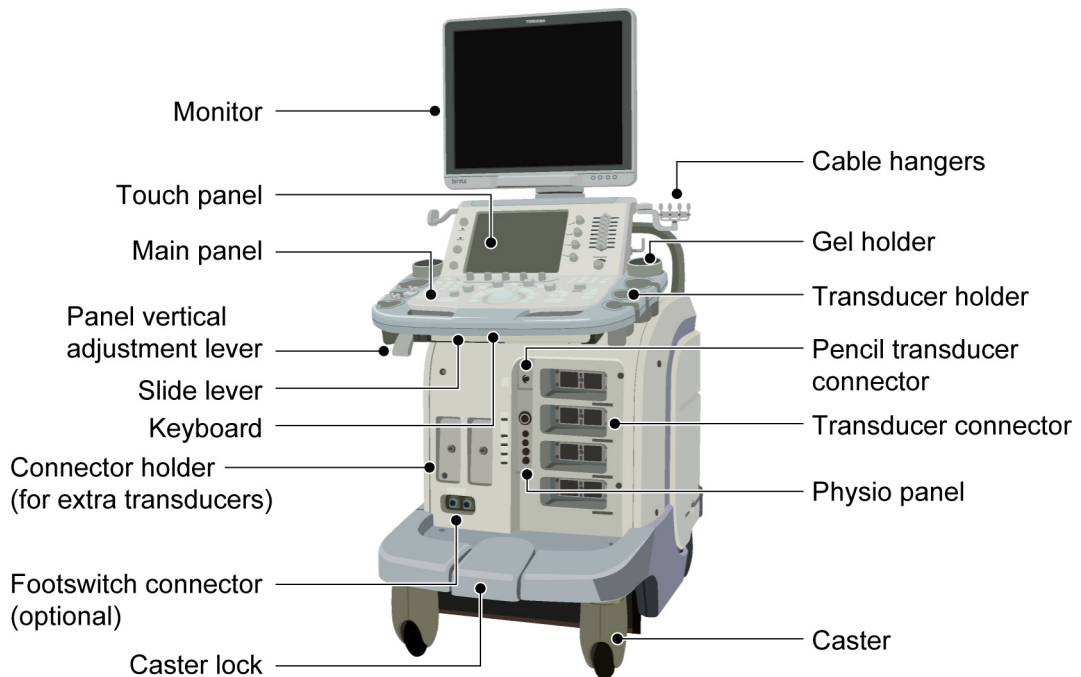



- Systems with the main power switch on the side

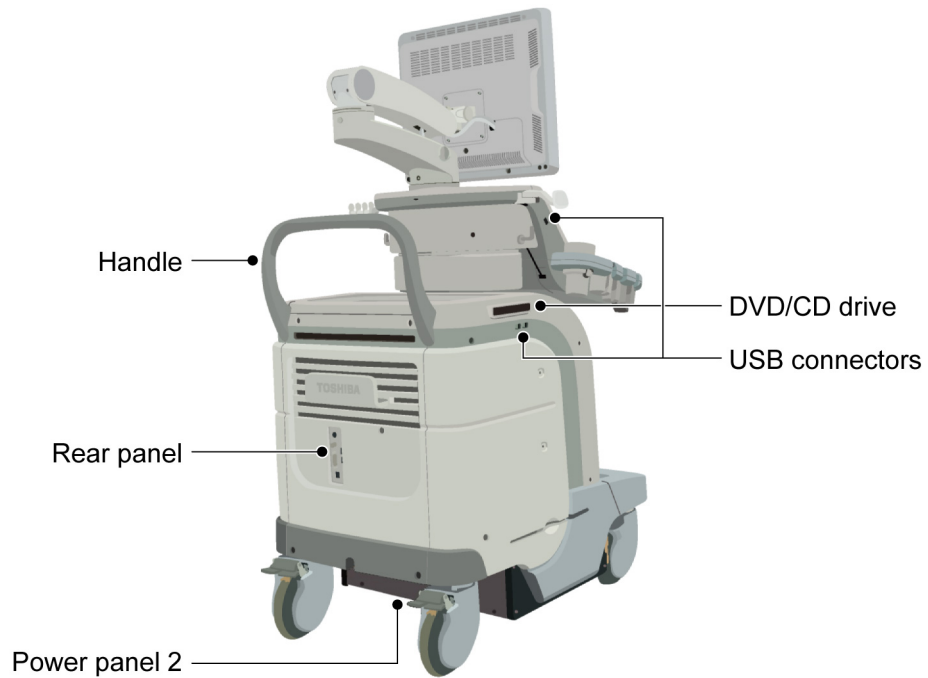
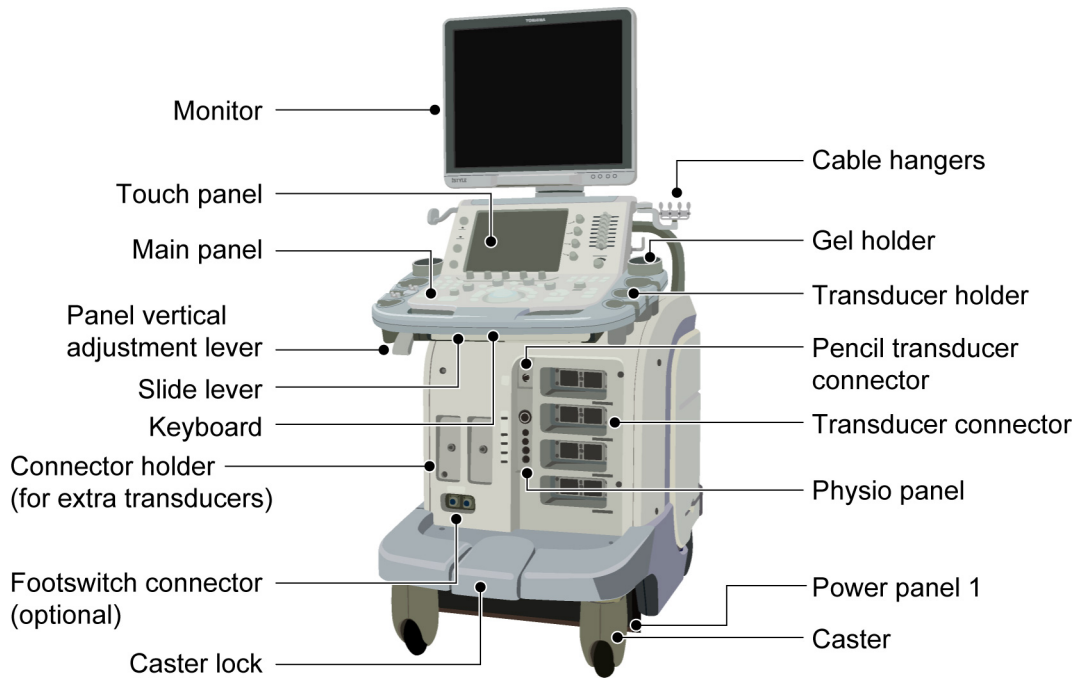







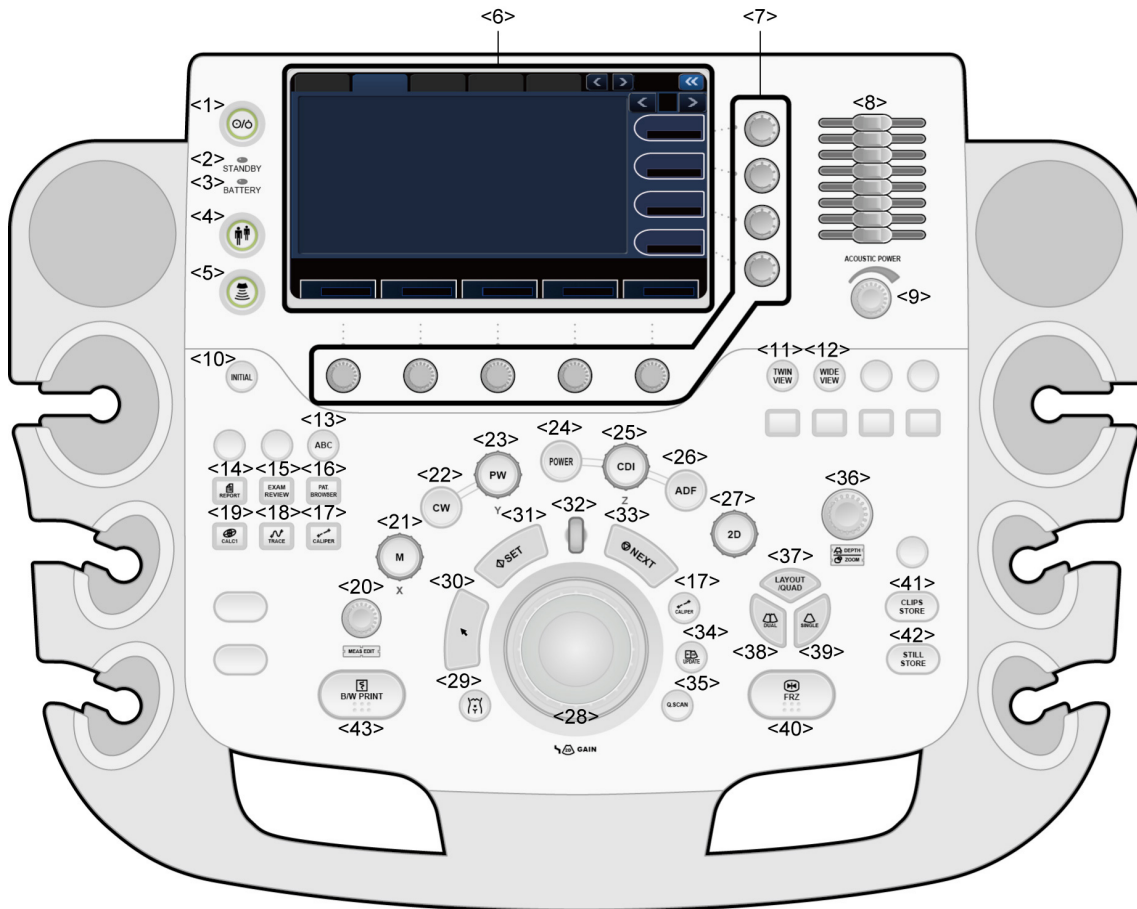







## 6.2 Main Panel

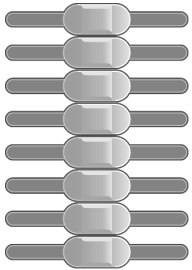













The default switch layout is shown in the figure below:















- The functions assigned to the switches can be changed. Therefore, the actual switch settings of the system may differ from the default settings described in this manual. Confirm the Output, Store, Freeze, and other important settings before using the system.
- It is also possible to change the positions of switches related to measurements, modes, or printer output (user function switches). To change the settings, contact your TOSHIBA service representative.



**CAUTION:** Do not press several switches at the same time. Doing so may cause a malfunction.

No.	Switch name	Function
<1>		Turns the power ON/OFF.
<2>	STANDBY 	Lights when the main power switch on the power panel is ON. Goes out when the system is started up. Lights again when the system is shut down.
<3>	BATTERY 	Indicates the battery charge level. (Lights when the main power switch on the power panel is ON.) Lights green if the batteries are adequately charged. Lights orange if the batteries need to be charged.
<4>		Displays the <b>[Patient Registration]</b> screen. The ID and measurement data for the previous patient are deleted and the initial conditions are restored.
<5>		Used to select the transducer.
<6>	Touch panel	Displays switches specific to the type of examination (switches for image control, measurements, etc.). The desired switch can be touched with a finger to operate it.
<7>		The functions of these knobs vary depending on the mode or other conditions. The functions currently assigned to the knobs are displayed on the touch panel.
<8>		Used to specify the echo reception sensitivity for various depths calculated from the body surface.
<9>	ACOUSTIC POWER 	Used to set the acoustic power.
<10>	INITIAL 	Returns the settings of scan range, Color ROI, and sampling gate to their initial values.
<11>	TWIN VIEW 	Displays monochrome and color images simultaneously in real time.
<12>	WIDE VIEW 	Starts trapezoid scanning.
<13>	ABC 	Enables text annotations to be added to images.
<14>	REPORT 	Starts the <b>[Worksheet]</b> screen.
<15>	EXAM REVIEW 	Starts the <b>[Exam Review]</b> screen.

No.	Switch	Function
<16>		Starts up the <b>[Patient Browser]</b> screen. Displays the previously acquired images or other data.
<17>	 	Starts basic measurement mode.
<18>		Starts basic measurement mode.
<19>		Starts application measurement mode.
<20>		The function of this knob varies according to the mode. Measurement modes : Used to edit measurement results (for example, modification of an ellipse or a trace). Body mark entry mode : Rotates the transducer mark on the body mark. Annotation mode : Rotates the arrow mark.
<21>		Switches to M mode. The dial around the knob is used to adjust the gain in M mode.
<22>		Switches to CW mode.
<23>		Switches to PW mode. The dial around the knob is used to adjust the gain in Doppler mode.
<24>		Switches to POWER mode.
<25>		Switches to CDI mode. The dial around the knob is used to adjust the gain in Color mode.
<26>		Switches to Dynamic Flow™ mode.
<27>		Switches to 2D display mode. The dial around the knob is used to adjust the gain in 2D mode.
<28>		Trackball : Used to move the cursor and measurement markers. Palm Dial : During real-time display : Used to specify the gain in 2D mode. In Freeze mode : Used to play back a loop in Cine review mode and to adjust the playback speed. Used to edit measurement results in measurement modes. Rotates the transducer mark on the body mark in Body mark entry mode. Rotates the arrow mark in Annotation mode.

No.	Switch	Function
<29>		Used to insert a body mark.
<30>		Turns display of the cursor ON/OFF. Used to manipulate thumbnails.
<31>		Used to switch trackball functions or specify the cursor position.
<32>	 (Wheel)	Pressing (in Freeze mode) : Returns to Cine mode (when Cine mode has been stopped due to a measurement operation, insertion of a body mark, insertion of an annotation, or a similar operation). Rotation : Feeds frames in Cine mode. Switches the displayed image in Exam Review mode.
<33>		Used to switch trackball functions or specify the cursor movement.
<34>		Displays 2D mode and M or Doppler mode images at the same time. Freezes/unfreezes the 2D mode image.
<35>		Used for automatic adjustment of the image quality. (Refer to <b>6</b> of subsection 14.1.2. "Adjustment using the main panel")
<36>		Used to specify the depth and the zoom level. Press to switch between depth and zoom modes.
<37>		Used to change the layout format.
<38>		Switches to the dual screen. Each time this switch is pressed, the real-time display is switched between the right and left images.
<39>		Switches to the single screen.
<40>		Freezes the screen.
<41>		Saves short dynamic image clips.
<42>		Saves still images.
<43>		Outputs data to the specified recording device. Monochrome printer is set as the default.

## 6.3 Rear Panel

**⚠ CAUTION:**

1. Do not connect any devices other than those specified by TOSHIBA to the USB connector or other connectors on the system.
2. Do not connect any device that is not compliant with the required safety standards to the Ethernet port. Doing so might cause smoke generation or electric shock.

**CAUTION:**

1. Connect or disconnect the Ethernet cable only when the power is OFF. If the cable is connected or disconnected while the power is ON, the system may malfunction.
2. If a hub is being used, turn ON the power of the hub before turning ON the power of the system. Otherwise, it may not be possible to establish connection with the network.

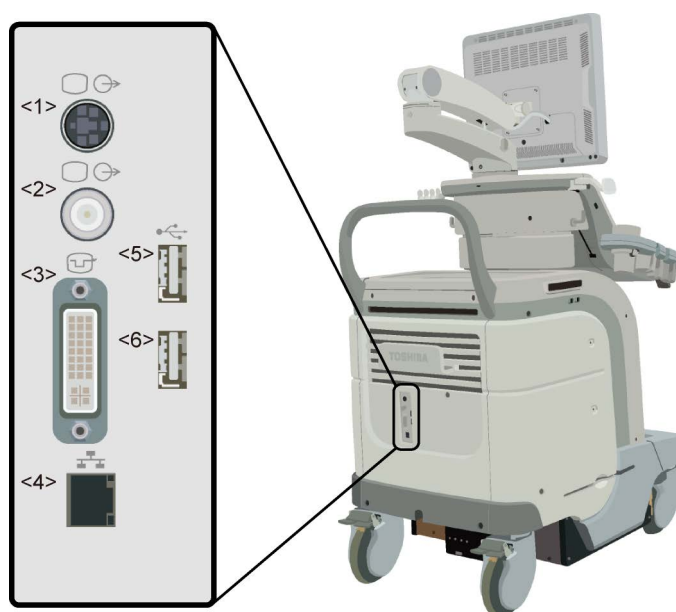





















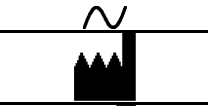

No.	Name	Function
<1>	S output terminal	Output terminal for external imaging device
<2>	Color composite terminal	Output terminal for external imaging device
<3>	External monitor DVI-I output	Output terminal for external digital imaging device
<4>	Ethernet port	Port for connection to a network for the transfer of digital images via the network
<5>	USB connector	Connector for connection of a USB device
<6>	USB connector	Connector for connection of a USB device

**NOTE:** The video recording unit and the printer must be connected connectors inside the system. Before connecting cables, contact your TOSHIBA service representative.

## 6.4 Symbols

The following symbols are used on this system. Note that the safety symbols are not shown here; they are shown in section 2 "General Safety Information".

Symbol	Description
	Functional ground
	Equipotential
	Main power switch OFF (AC power not supplied to system)
	Main power switch ON (AC power supplied to system)
	Power OFF (power not supplied to electronic circuits)
	Power ON (power supplied to electronic circuits)
	Transducer connector A
	Transducer connector B
	Transducer connector C
	Transducer connector D
	Pencil transducer connector
	ECG (Electrocardiogram)
	ECG (Electrocardiogram)
	PCG (Phonocardiogram)
	PULSE
	External input terminal
	Footswitch
	Alternating current (AC)
	Manufacturer
	Date of manufacture
	Serial number
	Authorized representative in the EC (on systems complying with European Directive 93/42/EEC)

# 7. Preparation for Examination

## 7.1 Moving and Installing the System

- ⚠WARNING:**
1. Use the system only on a level floor. Do not place the system at a location where the slope is 5° or more. Doing so may result in the system falling over and causing an injury.
  2. Do not push the system from the side. If the system is pushed from the side, it may fall down and cause injury.
  3. When the system is moved over a sloped surface, it must be moved slowly by two persons. Otherwise, the system may slide unexpectedly and cause a serious injury.
  4. When the system is moved over a step, be careful not to allow the system to fall. When holding the system at the bottom to help move it over a step, take special care to prevent hand injuries.

- ⚠CAUTION:**
1. Lock the casters once the system is moved to its installation location. Otherwise, the system may move unexpectedly, injuring the patient or the operator.
  2. Before moving the system, lock all movable sections, such as the LCD monitor main panel. Otherwise, parts may move unexpectedly, causing injury.
  3. Before moving the system, confirm that all peripheral devices are secured. If a peripheral device is not secured, it may fall, causing injury or damage.
  4. When a reference signal cable is used, disconnect it before moving the system. Otherwise, the cable might catch the feet or the casters, causing injury or damage.

- CAUTION:**
1. To prevent system malfunction, be sure to perform the following operations before moving the system.
    - (a) Turn OFF the power and also turn OFF the main power switch on the power panel.
    - (b) Stow the transducer in the transducer holder and hang the cables on the transducer cable hanger.
    - (c) Move the system using the handle. Do not attempt to move the system by pushing the panel or any part other than the handle.
  2. Except in emergencies, do not attempt to stop system movement by engaging the caster locks. Doing so may damage the casters.



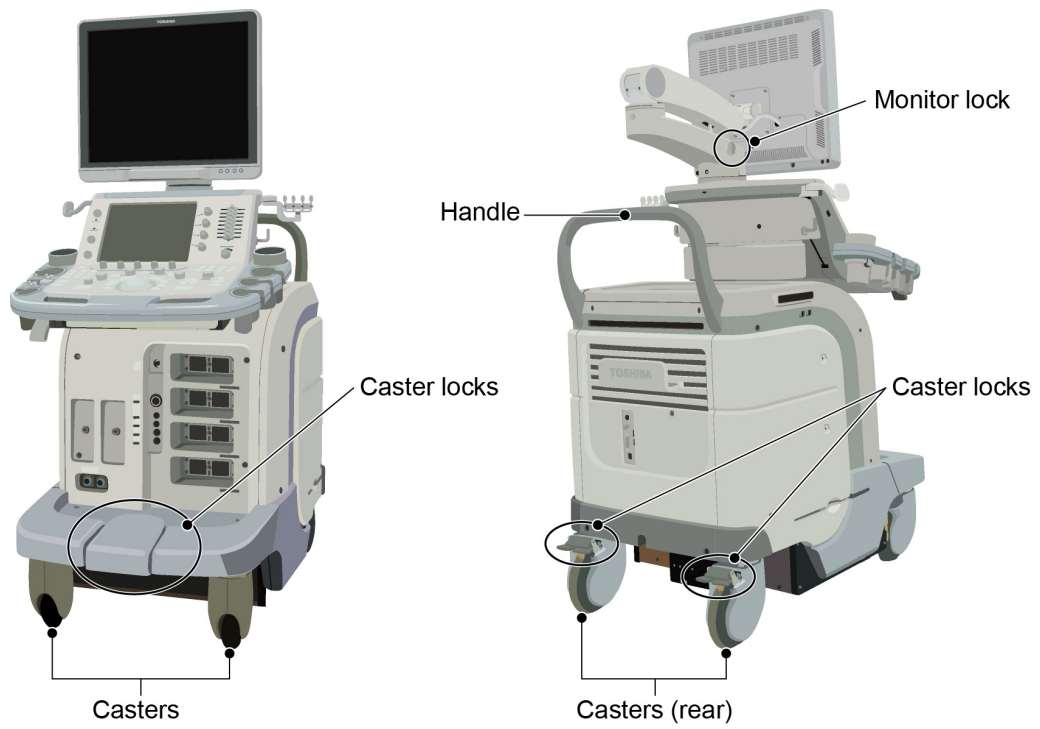

(1) Before moving the system, be sure to release the caster locks.

(a) Releasing all of the locks



(b) Locking the caster for forward motion



- (2) Move the system to its installation position using the handle.
- (3) Lock the casters.



## 7.2 Handling and Connecting/Disconnecting the Transducer

### 7.2.1 Handling the transducer

- CAUTION:**
1. Do not subject the acoustic lens surface of the transducer to shock by hitting it against a hard object or dropping it on the floor. A failure affecting the safety or functionality of the transducer may result.
  2. Do not apply stress to the transducer cable (tension, twisting, bending, pinching, etc.). The shield wire or signal wire inside the cable may break or short-circuit, which could result in electric shock to the patient or operator, or abnormal ultrasound images.
  3. Do not scratch or rub the acoustic lens surface of the transducer. This may cause the transducer to fail.

For other precautions concerning handling of the transducer, read all instructions provided in this operation manual and the operation manual supplied with the transducer.

### 7.2.2 Connecting/Disconnecting the transducer

- CAUTION:**
1. Be sure to turn OFF the power or select another transducer connector before connecting a transducer to or disconnecting the transducer from the currently selected transducer connector. Connecting a transducer to or disconnecting the transducer from the currently selected transducer connector can cause damage to the system or the transducer.
  2. Do not connect or disconnect a transducer during system startup or shutdown. Doing so may cause a malfunction.

(1) Connect the transducer.

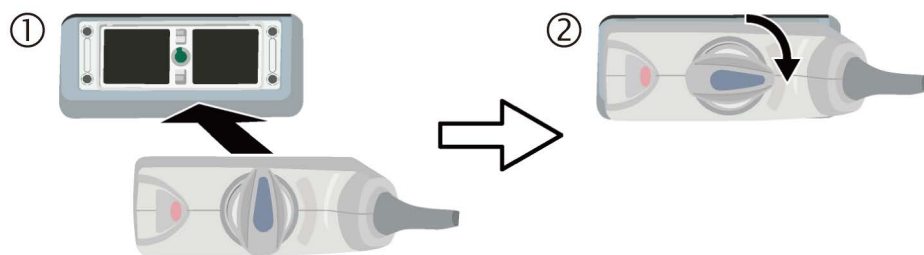

- (2) Hang the transducer cable on the cable hanger or cable hook and place the transducer in the transducer holder.

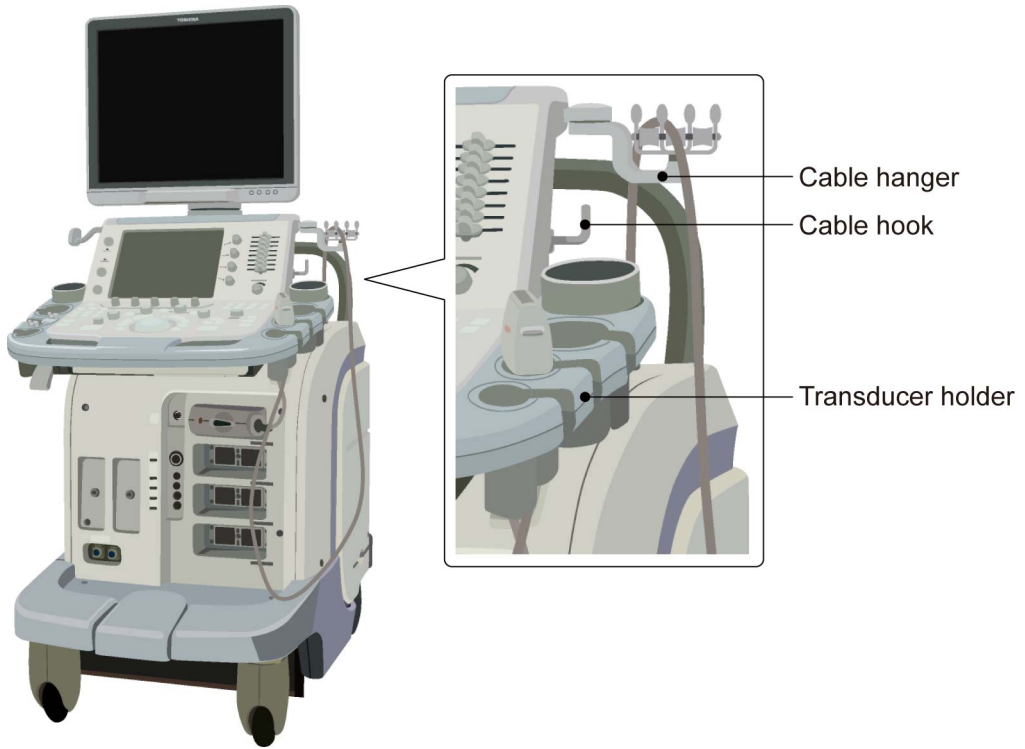

- (3) Disconnect the transducer.

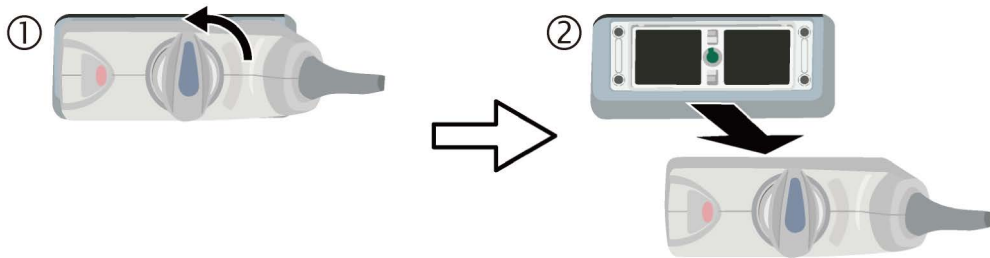

## 7.3 Adjusting the Main Panel

**CAUTION:** When lowering the main panel, do not subject the cable hanger, cable hook, or transducer holder to any loads. Doing so may damage them.

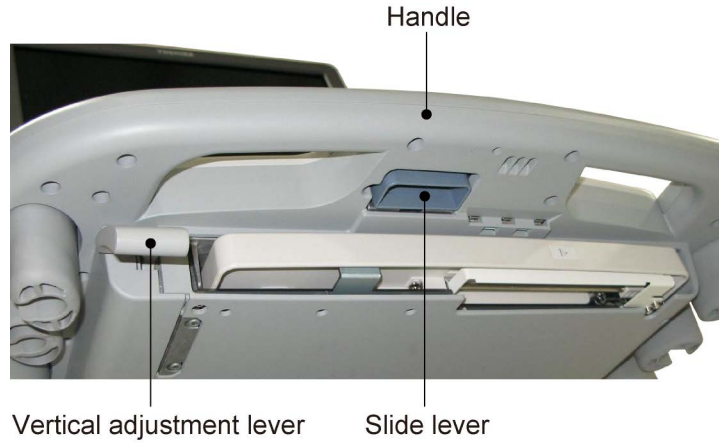

### 1 Adjusting the height of the main panel

Hold the handle and press the vertical adjustment lever upward to raise or lower the height.

When the lever is released, the position is locked.

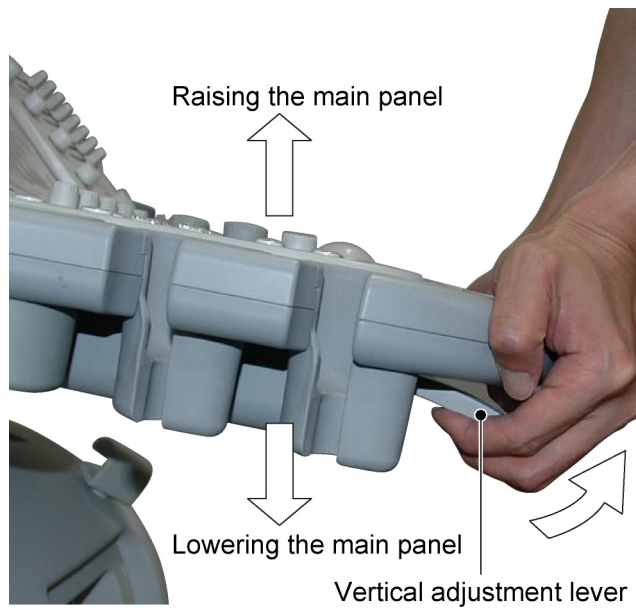

## 2 Adjusting the horizontal position of the main panel

- (1) Pull the slide lever toward you to release its lock.



- (2) While pulling the slide lever, hold the handle, move the main panel to adjust the position, and then release the slide lever. The nearest position is locked when the lever is released.

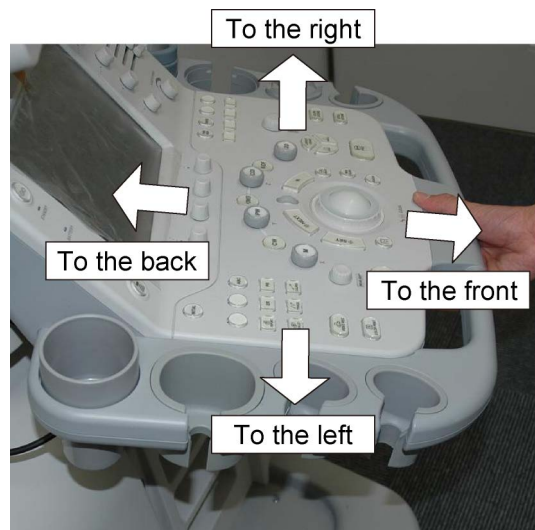

## 7.4 Adjusting the Monitor

**⚠ CAUTION:** Before moving the system, be sure to lock the movable section of the arm. Otherwise, the arm may move unexpectedly, resulting in an injury

### 7.4.1 Locking and releasing the monitor

#### 1 Locking and releasing the arm

<<Locking the arm>>

Lower the arm and turn the locking knob in the  direction.

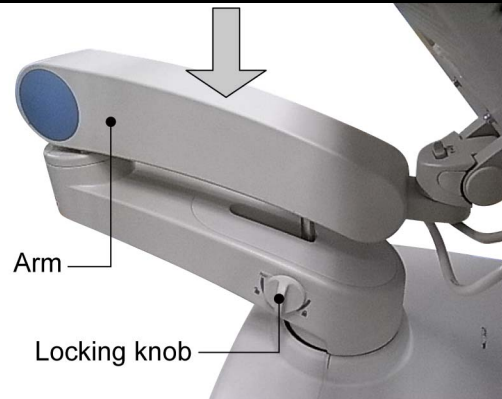

<<Releasing the arm>>

While pressing the locking knob, turn it in the  direction.



#### 2 Locking the monitor

① Slowly lower the monitor with the screen surface facing upward.

② Slide the latch to the locked position to lock the monitor.

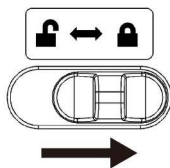

## 7.4.2 Adjusting the angle of the monitor

**⚠ CAUTION:** Do not touch the arm or the bottom of the monitor when adjusting the angle. Doing so may result in a hand injury.

### 1 Moving the monitor vertically

---

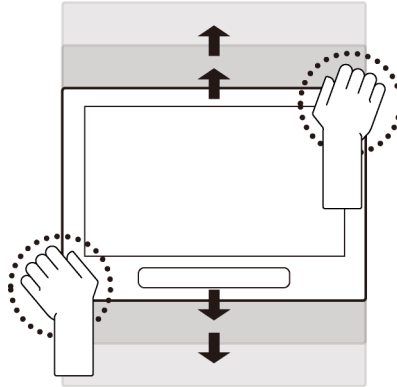

### 2 Moving the monitor horizontally

---

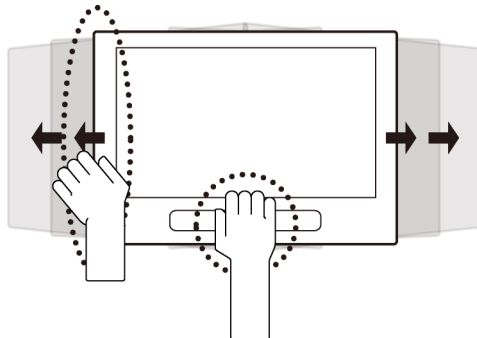



### 7.4.3 Adjusting the monitor display

The brightness (☀️) and the contrast (◐) can be adjusted as required using the buttons of the monitor.

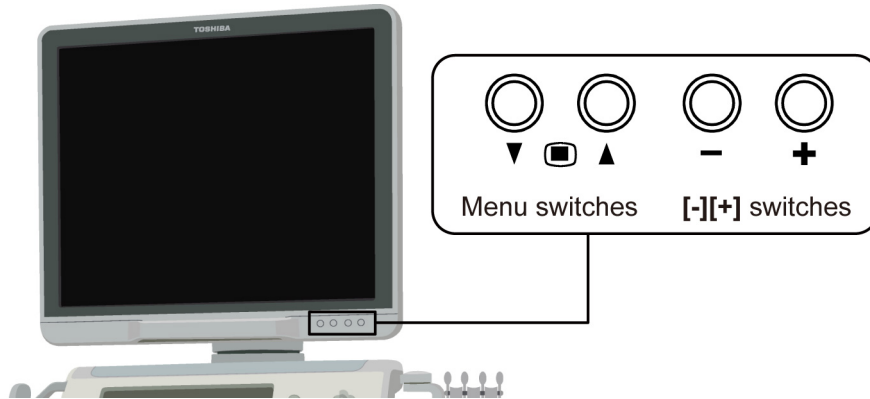

#### 1 Displaying the adjustment menu

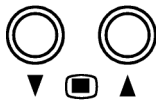

- Displaying the adjustment menu
- Selecting the menu item corresponding to the desired function

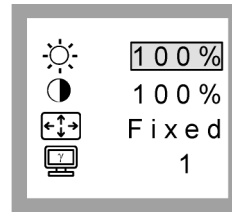

<<Adjustment menu>>

#### 2 Adjusting setting for the selected function

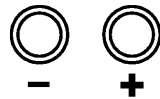

☀️ : Brightness

◐ : Contrast

↕️ : Fixed

γ : γ characteristics

- NOTE:**
1. To restore the factory default settings, press the **[+]** switch while holding down the **[-]** switch.
  2. Pressing the **[-]** switch while holding down **[▲]** of the Menu switches turns the monitor display ON/OFF.

## 8. Checks Before and After Use

In the interests of safety, it is the user's responsibility to carry out the following checks before and after using the system.

### 8.1 Checks Before Turning ON the Power

Perform the following checks before the system power is turned ON and after the system power is turned OFF.

No.	Check item	Check column
1	The temperature, humidity, and atmospheric pressure should meet the conditions of use.	<input type="checkbox"/>
2	There should be no condensation.	<input type="checkbox"/>
3	There should be no deformation, damage, or stains to the system and peripheral units. * If any stains are present, perform cleaning referring to subsection 20.3.1 "Cleaning the system".	<input type="checkbox"/>
4	There should not backlash or loose screws in the casters, monitor, panel, etc.	<input type="checkbox"/>
5	Caster locks should function correctly.	<input type="checkbox"/>
6	There should be no damage to the reference signal cable and no looseness of the connector.	<input type="checkbox"/>
7	There should be no abnormalities such as damage, wear, or bent pins on the power cable or plug.	<input type="checkbox"/>
8	There should be no abnormalities or stains of the transducer surface, cable sheath, or connector, such as peeling, cracks, protruding parts, or loss of firmness of the acoustic lens. * If any stains are present, perform cleaning, disinfection, or sterilization referring to the operation manual provided with the transducer.	<input type="checkbox"/>
9	No clips etc. are placed on the main panel or keyboard.	<input type="checkbox"/>
10	There should be no obstacles near the movable sections and air filter of the system.	<input type="checkbox"/>

## 8.2 Checks After Turning ON the Power

Perform the following checks after the system power is turned ON and before the system power is turned OFF.

No.	Check item	Check column
1	There should be no abnormal sound, unusual smells, or overheating.	<input type="checkbox"/>
2	No error message is displayed.	<input type="checkbox"/>
3	There should be no obviously abnormal noise, discontinuous display, or dark areas for 2D-mode images.	<input type="checkbox"/>
4	There should be no abnormality in the date and time. * Refer to the operation manual Applications volume for the procedures for changing the system time.	<input type="checkbox"/>
5	The acoustic lens surface of the transducer should not be unusually hot. (Perform check by hand.)	<input type="checkbox"/>
6	Switches and knobs on the panel should function normally.	<input type="checkbox"/>
7	There should be no abnormality in the color or display position of images output on a printer or recorded on a video recording unit.	<input type="checkbox"/>

**NOTE:** IQ Report Feature

If an error message appears or an image with unsatisfactory quality is displayed, use the IQ Report feature to save the image and the system information.

<<Quick Procedure>>

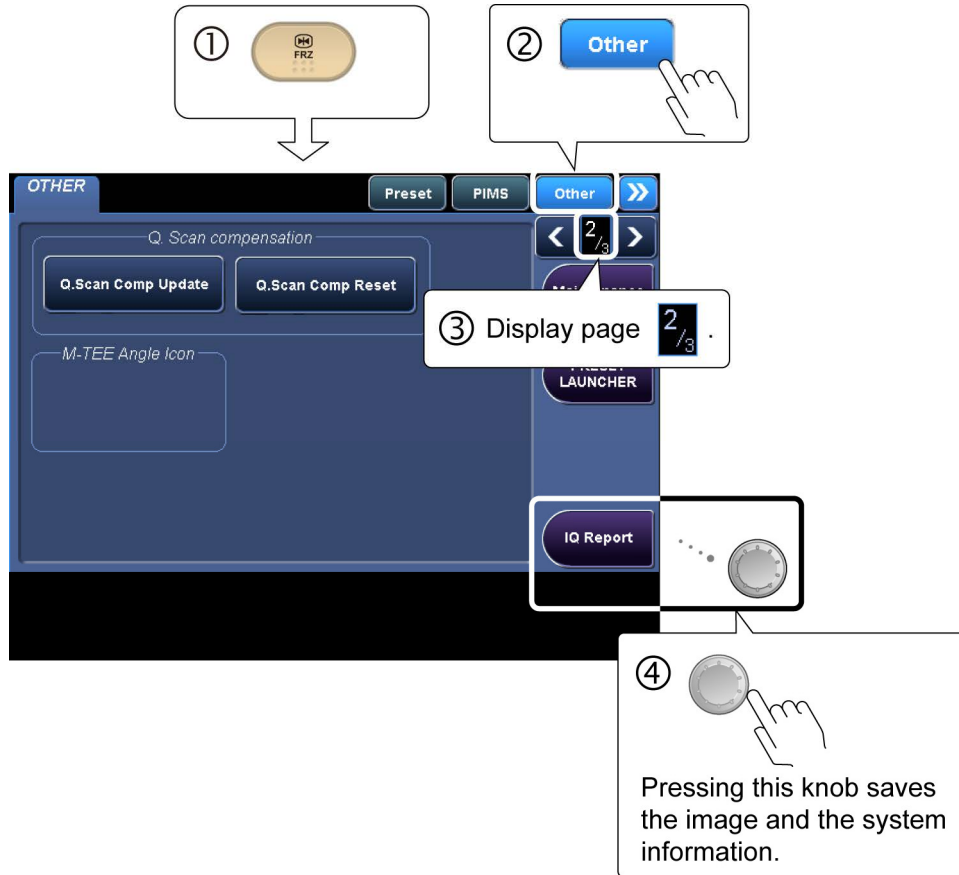



\* If it is not possible to perform the operation above (the menu pane is not displayed, etc), perform the following operation.



After the operation above is completed, contact your TOSHIBA service representative.

## 9. Turning the Power ON/OFF

- ⚠WARNING:**
1. Follow the instructions below regarding the power cable and plug.
    - Insert the power plug only into a 3-pin (with protective grounding) medical electrical outlet.
    - Do not connect the power cable to a 2-pin outlet using an adapter.
    - Do not forcibly bend the cable.
    - Do not modify the power cable or plug.
    - Do not damage the power cable or plug.
    - Do not twist the power cable or plug.
    - Do not bundle the power cable or plug.
    - Do not place heavy objects on the power cable or plug.
    - Do not pinch the power cable or plug.
    - Do not subject the power cable or plug to impact.
    - Do not pull the power cable to disconnect the plug from the outlet.
  2. Connect the equipotential terminal (  ) of this system to the equipotential bus of the facility using an equipotential conductor. When this system is used close to a device that is applied directly to the patient heart (such as in a cardiac catheterization room, CCU, or ICU), voltage equalization with the device is required to prevent an electric shock to the patient.
  3. A functional ground terminal (  ) is used to connect a functional grounding wire between systems or between the system and the ground for functional purposes of the system (for example, to eliminate potential differences in the signal level between systems or to eliminate potential differences between the system and the ground). Do not use the functional ground terminal for protective grounding. Also, do not connect the functional ground terminal to a gas pipe or water pipe. Doing so may result in the failure of functional grounding or in a gas explosion.
  4. Use a separate socket with an appropriate rated capacity for the supply of power to this system.
  5. Do not connect this system to an outlet that shares a circuit breaker (or fuse) with an outlet to which a device such as a life-support system is connected. If this system malfunctions and generates an overcurrent, or if there is a current surge when the power is turned ON, the circuit breaker may trip (or the fuse may blow).

**⚠ WARNING:** 6. Do not connect the diagnostic ultrasound system to the same power outlet as another device. Doing so may cause the circuit breaker of the facility to trip, fuses to blow, or a fire or electric shock to occur.

## 9.1 Connecting the Power Cable and the Protective Grounding

- (1) Connect the power plug to an outlet for medical equipment. By doing this, the protective ground line is connected.

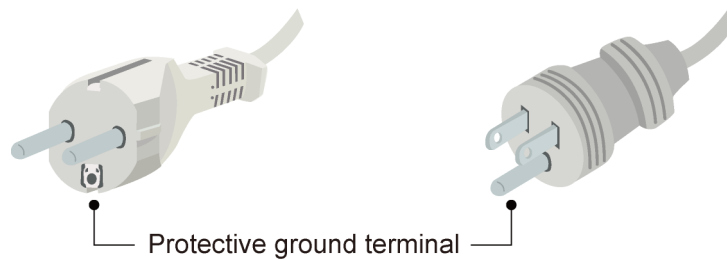

- (2) Turn ON the main power switch on the power panel.

The [STANDBY] LED lights.

- Systems with the main power switch on the rear

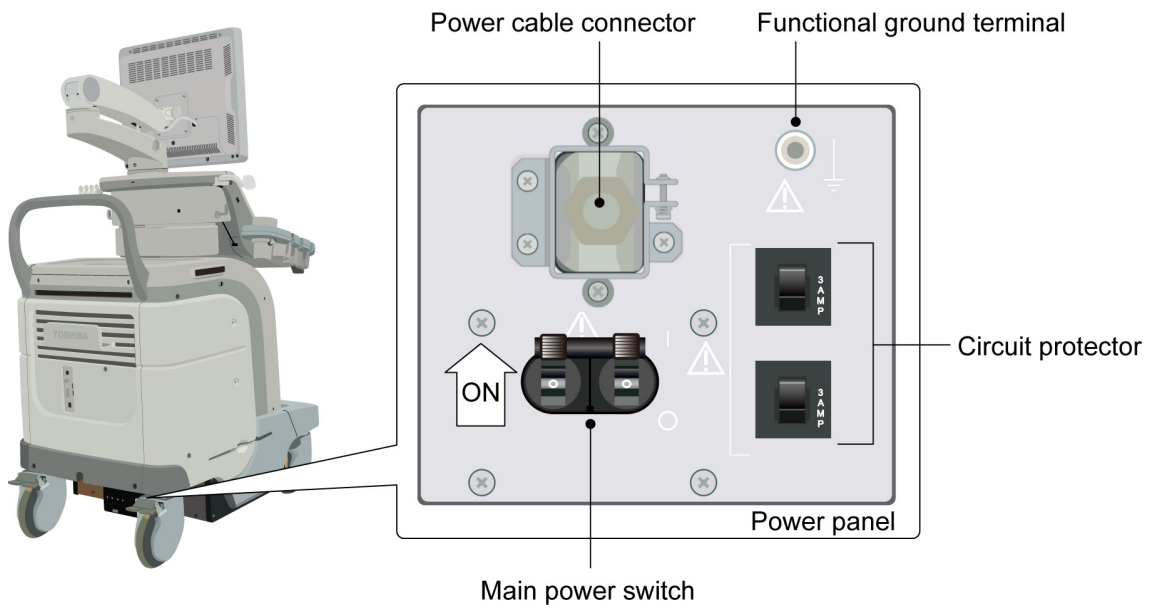

- Systems with the main power switch on the side

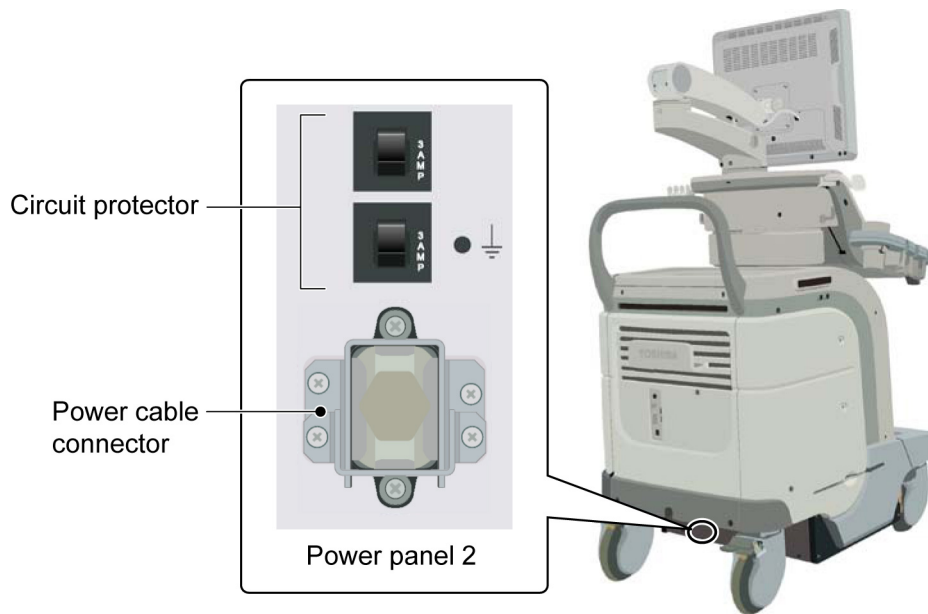
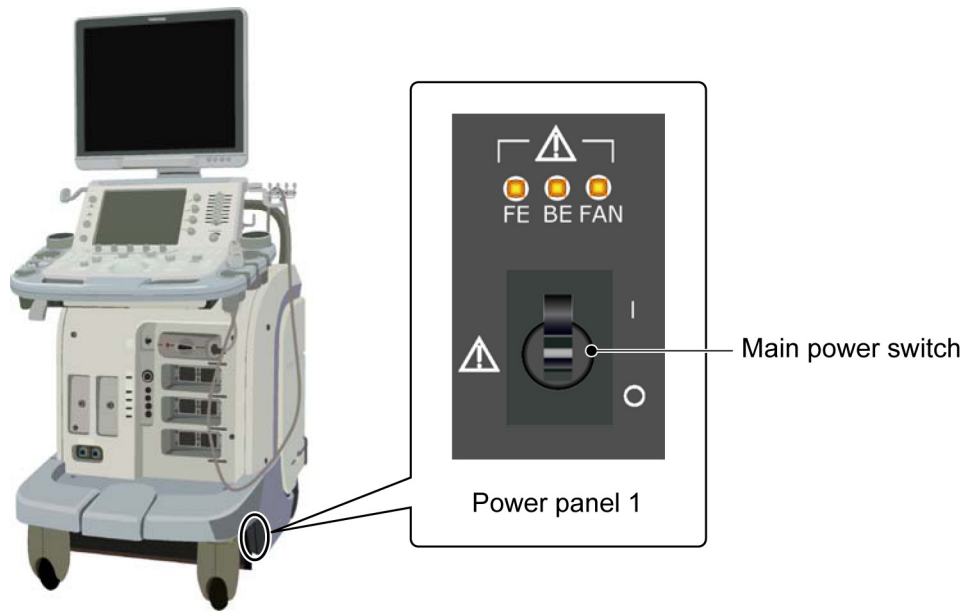

## 9.2 Turning ON the Power

**CAUTION:** 1. Do not disconnect the power plug while the system is starting up. Doing so may cause the system to malfunction.

2. If either of the following phenomena occurs, press and hold down  for 5 seconds or more to turn OFF the power of the system.

- The startup screen is not displayed after waiting for 30 seconds.
- The patient registration screen is not displayed after waiting for 10 minutes.

If the power is not turned ON after holding down  for 5 seconds or more, turn OFF the main power on the power panel. Do not turn OFF the power in this manner during normal operation. Doing so may cause the system to malfunction.

**NOTE:** 1. If the power is turned ON while a USB device, such as a flash drive, is connected to one of the five external USB connectors, the system may not start normally. Disconnect any USB device(s) before turning the power ON.

2. When turning ON the power, confirm that the **[STANDBY]** LED is lit and then press .

3. Do not operate the operating panel switches or keyboard while the system is starting up. The system may not start up normally.

4. After the main power has been turned OFF on the power panel, wait for at least for 15 seconds before turning the power ON again. If the main power switch is turned ON immediately after the power has been turned OFF, the system may malfunction.



- ① Before turning ON the power, confirm the following:
- The power cable is connected and the main power switch is ON.
  - The **[STANDBY]** LED is lit.
  - The transducer is connected.
  - If a hub is used, the power of the hub is turned ON.



②



③ The startup screen is displayed.



④ The **[Patient Registration]** screen is displayed (refer to section 11 "Starting an Examination").

- NOTE:**
1. For a cold boot, the time required to display the ultrasound image is usually approximately 3 minutes, but varies according to the system conditions.
  2. If the registration screen is closed without registering any patient data, the 2D mode screen appears and the system enters Freeze mode.
  3. Directly after the system power is turned ON, the fan noise is initially loud but reduces after a short while.

## 9.3 Turning the Power OFF

- CAUTION:**
1. If the power cannot be turned OFF by the normal procedure, press and hold down  for at least 5 seconds. If the power is still not turned OFF, turn OFF the main power switch on the power panel. These methods should not be used under normal conditions. They may damage the system.
  2. Do not turn OFF the power while printing or data saving or retrieval is in progress. Doing so may result in printing being terminated prematurely or in data being lost. Also, if the power is turned OFF during access to media, the media may be damaged.
  3. Do not turn the system power OFF during video recording. Doing so may damage the hard disk of the video recording device or the inserted media.

**NOTE:** If the power is turned OFF while a USB device, such as a flash drive, is connected to one of the five external USB connectors, the system may not shut down normally. Disconnect any USB device(s) before turning the power OFF.

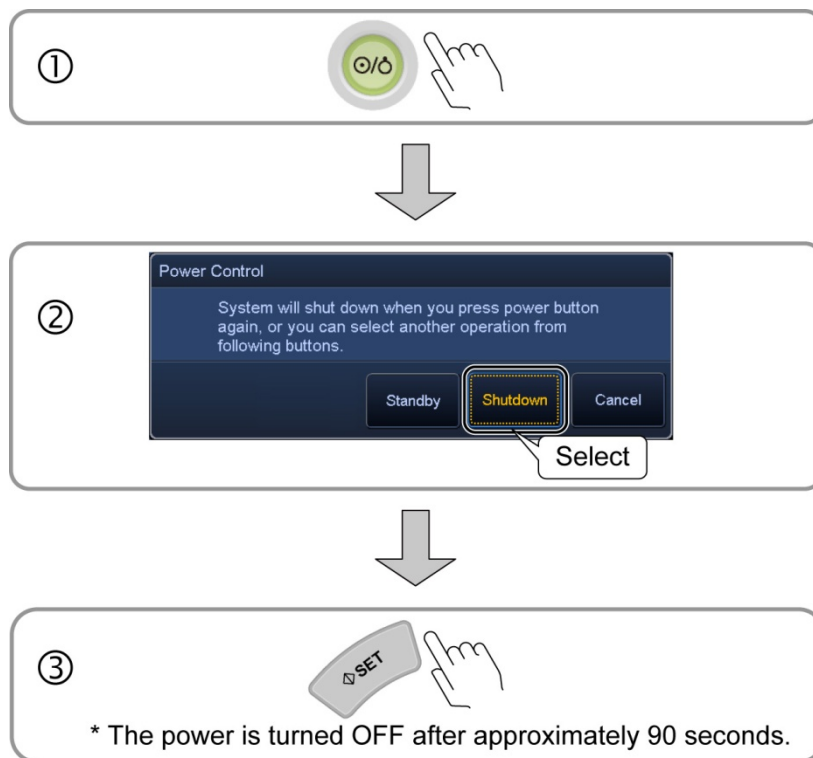

- NOTE:**
1. If the system is unlikely to be used for a long period after the power is turned OFF, turn OFF the main power switch on the power panel and then unplug the power cable.
  2. If the power cannot be turned OFF by following the normal procedures, 2D mode images may not be displayed when the system power is turned ON again. In this case, perform the following procedures:
    - Shut down the system and turn OFF the main power switch on the power panel on the rear of the system.
    - Wait for at least 15 seconds, turn ON the main power switch on the power panel, and then turn ON the power again.
  3. After the main power has been turned OFF on the power panel, wait for at least 15 seconds before turning the power ON again. If the main power switch is turned ON immediately after the power has been turned OFF, the system may malfunction.
  4. The following message may be displayed during operation.



This message indicates that a problem has occurred with the patient data handling functions (image storage, playback, or deletion) and that the system has entered restricted operation mode to protect the data. In restricted operation mode, do not use the Store, Exam Review, or Patient Browser functions. If these functions are used, the patient data handling functions cannot be performed. Reboot the system as soon as the current examination is completed.

Note that the message can be cleared by clicking **[Close]** and scanning can be performed normally.

**NOTE:** 5. When **[Shutdown]** is selected in the **[Power Control]** dialog during copying of patient data, transfer of patient data, or burning of patient data onto a CD/DVD, the following dialog is displayed.

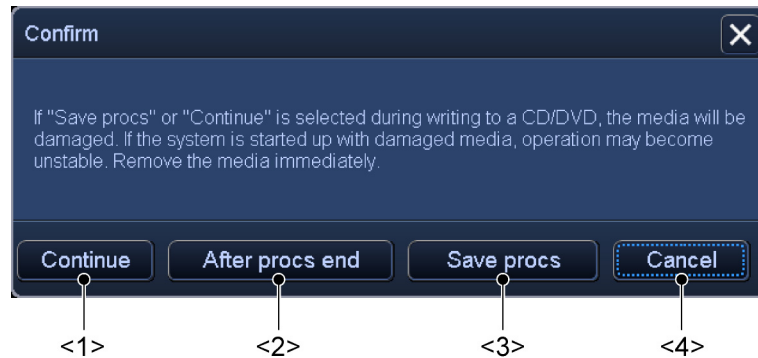

No.	Item	Function
<1>	<b>[Continue]</b>	The current process is terminated and the shutdown process is started. If this is selected during CD/DVD burning, the burn process is canceled (the CD/DVD will be damaged) and the shutdown process is started.
<2>	<b>[After procs end]</b>	The shutdown process is started after the current process is completed.
<3>	<b>[Save procs]</b>	The current process is paused (resumed) and the shutdown process is started. If this is selected during CD/DVD burning, the burn process is canceled (the CD/DVD will be damaged) and the shutdown process is started.
<4>	<b>[Cancel]</b>	The dialog is closed and the current process is continued.

## 9.4 Standby Mode

Standby mode is a function for suspending system operation without shutting down the system completely.

**CAUTION:**

1. Do not set the system to Standby mode while printing or data saving or retrieval is in progress. Doing so may result in printing being terminated prematurely or in data being lost. Also, if the power is turned OFF during access to media, the media may be damaged.
2. Do not set the system to Standby mode during video recording. Doing so may damage the hard disk of the video recording device or the inserted media.

### 9.4.1 Setting Standby mode

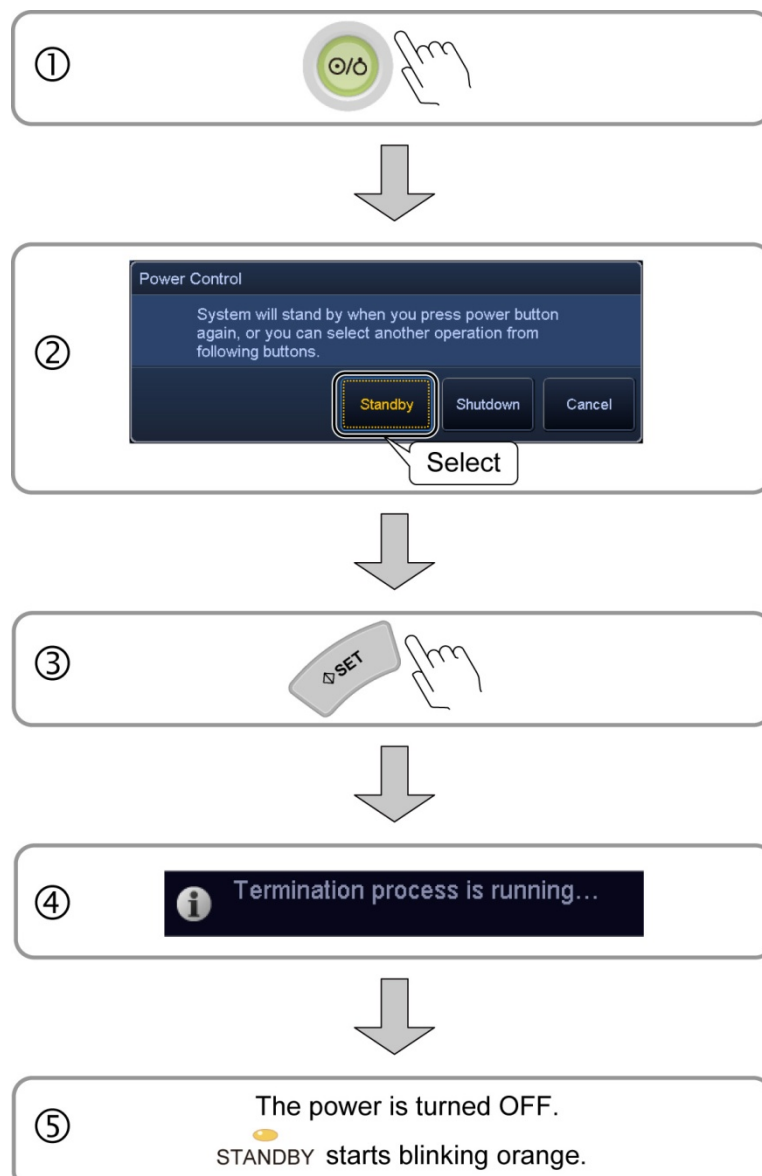

- NOTE:**
1. A message recommending standard power OFF (shutdown) is displayed in the following cases.
    - The continuous power ON time<sup>\*1</sup> has exceeded 48 hours or the cumulative power ON time<sup>\*2</sup> has exceeded 3.5 days (84 hours).  
Displayed message: **[Due to the length of elapsed time since Startup, Shutdown is recommended.]**
    - The system has been started up from Standby mode 7 times or more continuously.  
Displayed message: **[Overuse of resume. Shutdown is recommended.]**
  2. In the following cases, a message is displayed and the Standby function cannot be used. Turn the system power OFF in standard mode (shutdown).
    - The continuous power ON time<sup>\*1</sup> has exceeded 96 hours or the cumulative power ON time<sup>\*2</sup> has exceeded 5 days (120 hours).  
Displayed message: **[Due to the length of elapsed time since Startup, select Shutdown or Cancel.]**
    - The system has been started up from Standby mode 10 times or more continuously.  
Displayed message: **[Overuse of resume. Select Shutdown or Cancel.]**
- \*1: This is the cumulative time for which the system has been used continuously.
- \*2: When Standby mode is used, this is the cumulative time for which the system power has been ON after the system power was last turned ON in standard mode (the standby periods are not included).
3. The standby function cannot be used in the following cases. In such cases, the message shown below is displayed. When the use of these functions is completed or terminated, the Standby function becomes effective again. Note that if any settings of the functions have been changed, the system power should be turned OFF in standard mode (shutdown).
    - When using a maintenance function or a preset function  
Displayed message: **[You can only select shutdown from maintenance menu.]**
    - When a USB flash drive is connected  
Displayed message: **[Standby is disabled while the USB flash drive is connected.]**
  4. If the main power switch on the power panel is turned OFF or the system power cable is disconnected while the system is in Standby mode, Standby mode is canceled and the system is started up in standard power ON mode. If the battery kit (option) is installed, Standby mode is maintained even when the main power switch on the power panel is turned OFF during Standby mode. If the battery level is low, however, the system is started up in standard power ON mode when it recovers from the Standby status.
    - If the battery kit is installed, the battery is charged automatically while the main power switch on the power panel is ON.
    - The battery is intended to maintain the memory that stores system information required for the Standby function. The system cannot be started up using the battery only.
    - Contact your TOSHIBA service representative for the battery kit.

**NOTE:** 5. Do not connect a USB device such as a flash drive to any of the external USB connectors (the system is provided with five USB connectors) when the system is in the Standby status. Doing so may result in the system not starting up normally from the Standby status.

#### 9.4.2 Recovery from the Standby status

**CAUTION:** 1. Do not disconnect the power plug from the outlet while the system is resuming after being paused. The system may malfunction.

2. If either of the following phenomena occurs, press and hold down  for 5 seconds or more to turn OFF the power of the system.

- The startup screen is not displayed after waiting for 30 seconds.
- The patient registration screen is not displayed after waiting for 10 minutes.

If the power is not turned ON after holding down  for 5 seconds or more, turn OFF the main power on the power panel. Do not turn OFF the power in this manner during normal operation. Doing so may cause the system to malfunction.

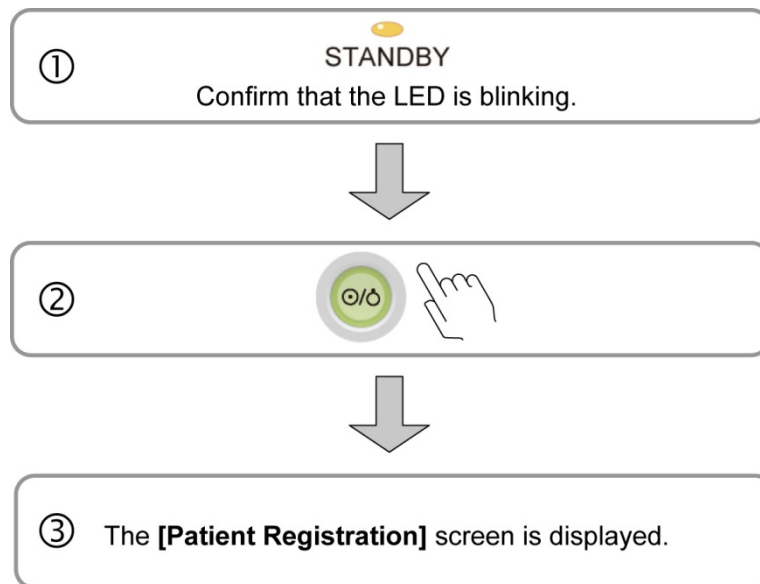

**NOTE:** 1. When resuming the system from pause status, confirm that the **[STANDBY]** LED is blinking and then press .

2. Do not operate the operation panel switches or keyboard while the system is recovering from Standby status. The system may not start up normally.

3. Normally, the ultrasound image is displayed approximately 1 or 2 minutes after the power switch is pressed in the standby status; however, the actual time required varies depending on the system status.

- NOTE:**
4. Directly after the system power is turned ON, the fan noise is initially loud but reduces after a short while.
  5. Rarely, the message shown below may be displayed when an attempt is made to start the system from the Standby status. In such cases, select [OK] to close the message dialog. Then shut down the system and start it up again.  
Displayed message: **[The system failed to start. Please restart the system. Error code: XXX]**
  6. After the main power has been turned OFF on the power panel, wait for at least 15 seconds before turning the power ON again.  
If the main power switch is turned ON immediately after the power has been turned OFF, the system may malfunction.

## 9.5 Preparation for Use During Surgery or for Emergency Cases

**⚠WARNING:** Prepare a backup system when an urgent examination is to be performed, for example during an operation or for an emergency case. If a severe problem should occur with the system, the normal operation of the system may not be recovered by turning the power OFF/ON and the examination may not be able to continue.

### 9.5.1 Preparation of a backup system

Prepare a backup system when an urgent examination is to be performed (for example, examination during emergency surgery).

### 9.5.2 Power OFF/ON in the case of system failure

When any of the following abnormalities occurs in the system, recovery may be possible by turning the system power OFF/ON.

- An error message is displayed and does not disappear.
- The screen display is abnormal.
- System operations are disabled.

If the system is still abnormal even after power OFF/ON, use the backup system.

**NOTE:** When turning ON the power, confirm that the **[STANDBY]** LED is lit and then press .



# 10. Basic Screen and Menu

## 10.1 Display of Various Data Items

In addition to ultrasound images, various data items are displayed on the monitor.

This section describes the screen display common to all modes. Refer to section 14 "Display and Operation in Each Mode" for the display specific to each mode.

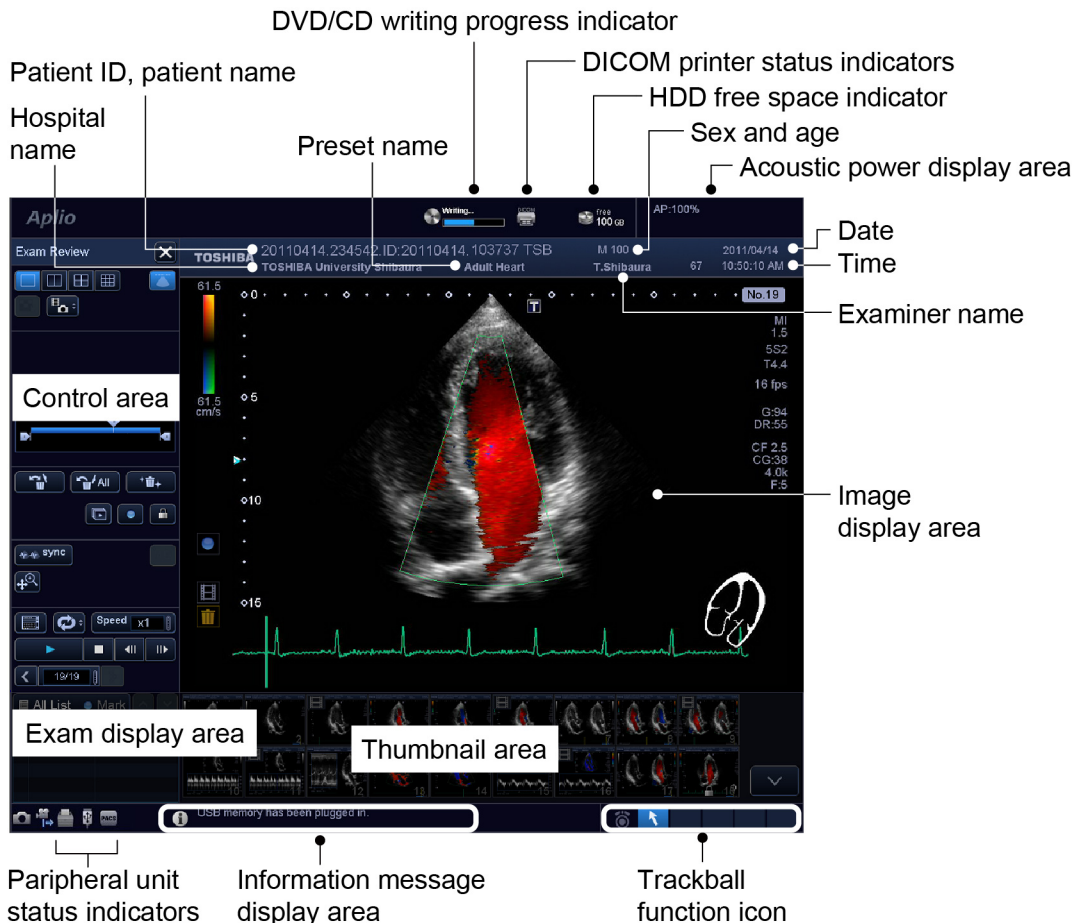

**CAUTION:** The free space on the hard disk is displayed at the top of the screen as "free 100GB". If there is less than 35 GB of free space, the icon is highlighted in yellow. The color of the free space indicator changes to red when the free space falls below 20 GB. When the free space falls below 1 GB, the message [HDD is full. Please delete some images in Patient Browser and try again.] is displayed in the information message display area on the screen and no more data can be stored. Delete unnecessary data before saving new data.

\* For the data deletion procedure, refer to section 2 of the operation manual, Applications volume.

**CAUTION:** When  at the bottom left of the screen lights, it indicates that the system is ready to output images to the printer. Confirm that printing is completed by checking the printed images output from the printer. Note that if the next print operation is performed while this icon is lit, the next image is not printed. Wait until the icon goes out before performing the next print operation.

## 10.2 Displaying the Acoustic Power Data

The acoustic power data transferred from the transducer is displayed in the image display area and in the acoustic power display area.

**NOTE:** Whether or not the acoustic power data is displayed depends on the mode. If the value is low, display is not performed.

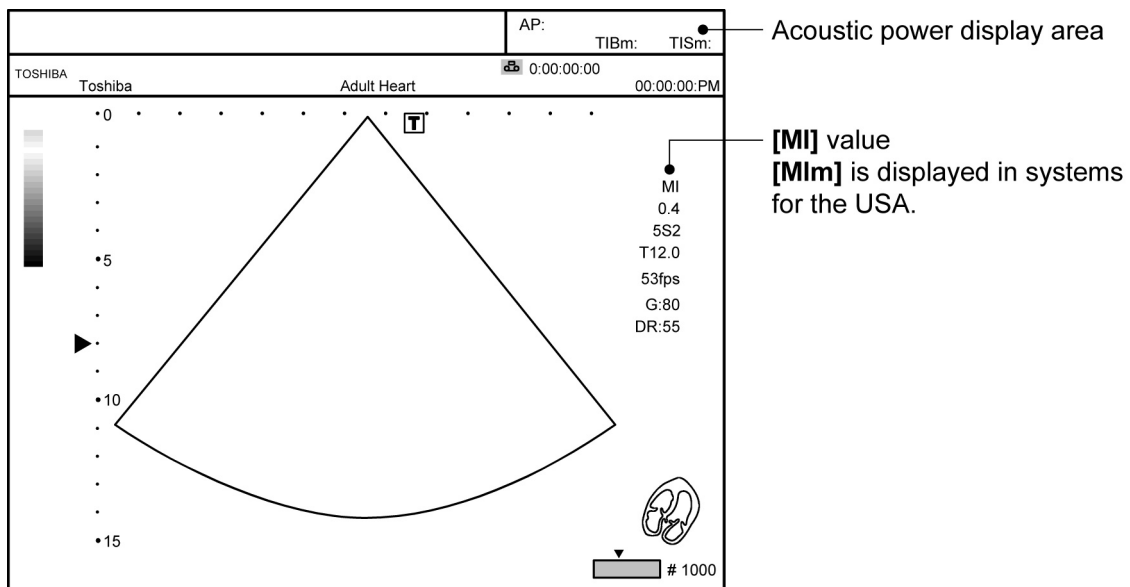

<Except for USA and Canada>

No.	Label	Description	Display location
<1>	<b>[AP]</b>	Acoustic power The current transmission value (%) is displayed.	Acoustic power display area
<2>	<b>[TIS]</b>	Thermal index soft tissue Displayed as the calculated/estimated value for temperature increase in the soft tissues.	Acoustic power display area
<3>	<b>[TIB]</b>	Thermal index bone Displayed as the calculated/estimated value for temperature increase in the cranial bones of a fetus or newborn child.	
<4>	<b>[MI]</b>	Mechanical index Displayed as the value related to the mechanical effectiveness such as cavitation.	Image display area

<Only for USA and Canada>

No.	Label	Description	Display location
<1>	<b>[AP]</b>	Acoustic power The current transmission value (%) is displayed.	Acoustic power display area
<2>	<b>[TISm]</b>	Thermal index soft tissue Displayed as the calculated/estimated mean value for temperature increase in the soft tissues.	Acoustic power display area
<3>	<b>[TIBm]</b>	Thermal index bone Displayed as the calculated/estimated mean value for temperature increase in the cranial bones of a fetus or newborn child.	
<4>	<b>[MIm]</b>	Mechanical index Displayed as the mean value related to the mechanical effectiveness such as cavitation.	Image display area

## 10.3 Thumbnail Display

The thumbnails representing the data acquired in the current study are displayed in the thumbnail area.

If previous study datasets for the same patient are present in the HDD, the study dates and exam types of these datasets are displayed in the study area. When a study date is clicked, the thumbnails representing the data for that date are displayed.

The system recognizes different studies as belonging to the same patient when all of the following items in the studies match.

Patient ID

Patient name

Sex

If any of these items do not match and the studies are therefore not recognized as belonging to the same patient, the patient information edit function (refer to subsection 2.2.6 of the operation manual Applications volume) of the **[Patient Browser]** can be used to make the system recognize these studies as belonging to the same patient.

# 11. Starting an Examination

- ⚠ CAUTION:**
1. Before starting an examination for a new patient, confirm that the patient ID matches the patient to be examined. If images are recorded with an incorrect patient ID, the data may be mixed up with that for another patient, resulting in incorrect diagnosis.
  2. Enter the height and the weight correctly. Otherwise, the BSA may be calculated incorrectly.
  3. Check the date format before entering the date of birth. Otherwise, the age may be calculated incorrectly.

- NOTE:**
1. Be sure to register and save the patient ID before starting an examination for a new patient. If measurement is performed for a new patient for whom the patient ID has not been registered or saved, the measurement results and other data cannot be saved in the system.
  2. Periodically back up the saved data (image data and exam history) to external storage media. Data stored in the system may be deleted as a result of an operational error or an accident (problems that occur in personal computers can also occur in this system).
  3. Delete unnecessary data regularly. If the available storage space is low, new data may not be saved.
  4. Before deleting data, confirm the date and the patient ID, patient name, etc. to ensure that incorrect data is not deleted.
  5. If patient data or exam data is to be modified, confirm that the modifications are correct before saving them. Once the data is saved, the previous data cannot be restored.
  6. If the rows of the History data in the patient data entry screen are switched, turn ON the system again.
  7. When the patient information is registered and  is then selected, the live image is normally displayed within 10 seconds. However, if relatively high-load processing (such as saving, loading, copying, or conversion of a large amount of data) is performed immediately before this, it may take approximately 30 seconds to display the live image. If the live image is not displayed after 30 seconds, an error message is displayed. Reboot the system.

# 11.1 Entering and Saving Data on the [Patient Registration] Screen

Start the exam by entering the patient details on the [Patient Registration] screen.

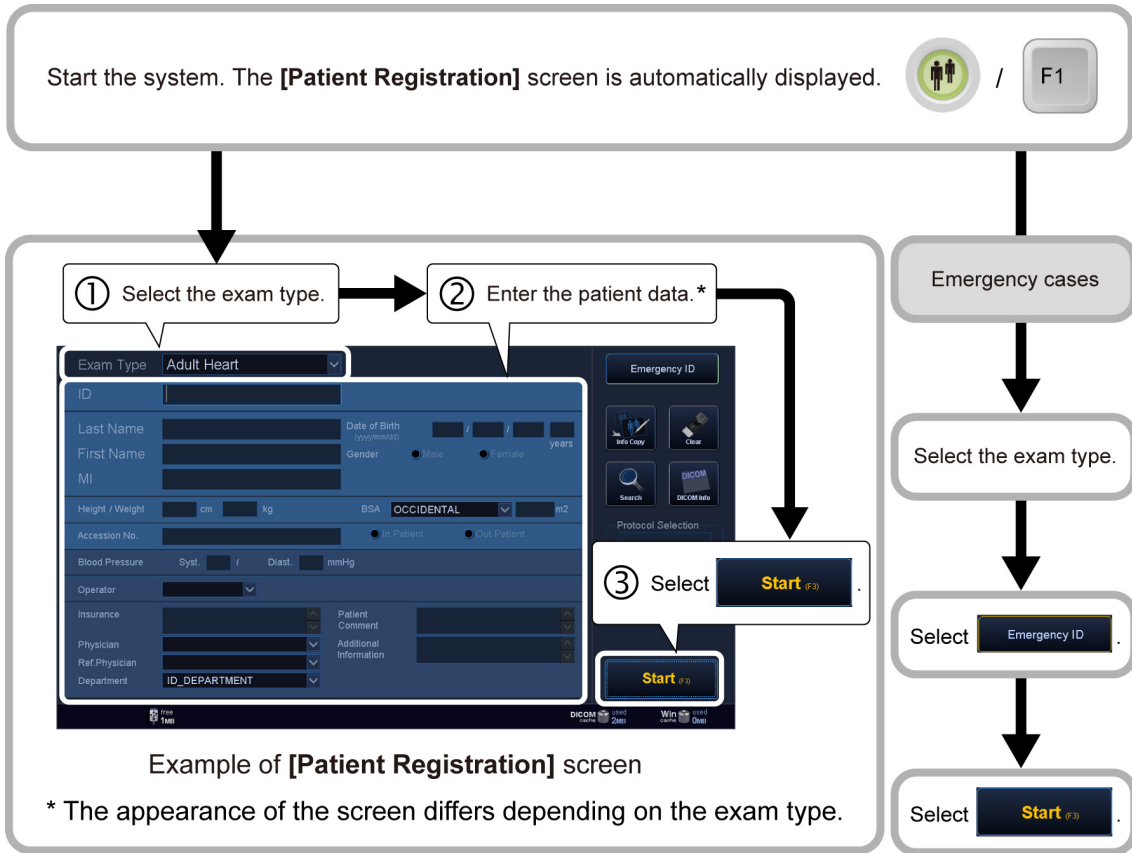

<<Exam types>>

Dropdown list item	Exam type
<b>[Abdomen]</b>	Abdomen general
<b>[Carotid]</b>	Carotid arteries
<b>[Thyroid]</b>	Thyroid glands
<b>[Breast]</b>	Breast, including mammary glands
<b>[OB]</b>	Obstetrics
<b>[GYN]</b>	Gynecology
<b>[Endo-Vaginal]</b>	Endovaginal
<b>[Fetal Heart]</b>	Fetus cardiovascular
<b>[Adult Heart]</b>	Cardiovascular
<b>[Pediatric Heart]</b>	Pediatric cardiovascular
<b>[Coronary]</b>	Coronary arteries
<b>[TCD]</b>	Transcranial Doppler

Dropdown list item	Exam type
<b>[Neo-Head]</b>	Neonatal head
<b>[Neo-General]</b>	Neonatal abdomen general
<b>[Neo-Hip]</b>	Neonatal hip joints
<b>[PV-Venous]</b>	Peripheral blood vessels (veins)
<b>[PV-Arterial]</b>	Peripheral blood vessels (arteries)
<b>[Digits]</b>	Peripheral blood vessels (fingers and toes)
<b>[MSK]</b>	Musculoskeletal
<b>[Prostate]</b>	Prostate gland
<b>[Kidney]</b>	Kidneys
<b>[Testes]</b>	Testes
<b>[OTHER]</b>	Others
<b>[M-TEE]</b>	Transesophageal

**NOTE:** 1. The ID and name are displayed as "date + unique character string". If more than one system is used at the site, be sure to set a unique character string so that the system can be identified.

2. Do not enter a patient ID consisting of spaces only. The examination will not start.

3. Equations for calculating BSA (body surface area)

BSA (m<sup>2</sup>) is calculated when patient height (cm) and weight (kg) are entered on the **[Patient Registration]** screen.

The following expressions are available for calculating BSA. The desired expression can be selected from a pull-down menu.

(a) Occidental

$$BSA = 0.007184 \times Height^{0.725} \times Weight^{0.425}$$

(b) Oriental (Adult)

$$BSA = 0.007358 \times Height^{0.725} \times Weight^{0.425}$$

(c) Oriental (12-14)

$$BSA = 0.010265 \times Height^{0.651} \times Weight^{0.423}$$

(d) Oriental (6-11)

$$BSA = 0.008883 \times Height^{0.663} \times Weight^{0.444}$$

(e) Oriental (1-5)

$$BSA = 0.038189 \times Height^{0.362} \times Weight^{0.423}$$

(f) Oriental (0)

$$BSA = 0.009568 \times Height^{0.655} \times Weight^{0.473}$$



4. It is also possible to enter the year of a date of birth using the Japanese calendar (combination of the era name "M (Meiji)", "T (Taisho)", "S (Showa)", or "H (Heisei)" and the year in the era). The entered year is converted into the corresponding Western calendar year and displayed.

<<Example>>

If "S42" is entered ..... The year is displayed as 1967.

5. When settings are added or deleted for any of the following items, the changes are applied only after the system is rebooted.

- **[Operator]**
- **[Physician]**
- **[Ref. Physician]**
- **[Department]**

- NOTE:**
6. If the patient's date of birth has not been entered on the **[Patient Registration]** screen, the date of birth is not displayed in the **[Comment]** field in the **[Patient Info]** display of **[Patient Browser]**, **[History Browser]**, or the patient/exam information editing form.
  
  7. The start function, which is normally assigned to , can be assigned to any other function key (  ) on the keyboard. To change key assignments, contact your TOSHIBA service representative.



# 12. Reference Signal Display

In the 2D, M, or M+2D (including Doppler) display modes, it is possible to display up to two types of reference signals of the electrocardiogram (ECG), the phonocardiogram (PCG), etc. This feature is optional.

**⚠WARNING:**

1. For protection against electric shock, confirm the following items before use:
  - There are no abnormalities in the reference signal cables.
  - The cable combination used is correct.
  - \* The reference signal cable supplied with the UJUR-A500A is used.
2. Connect the reference signal cables to the system before setting the ECG electrodes on the patient. Do not touch any conductive areas, including the grounding, while ECG electrodes are attached to the patient. If an electrode or a reference signal cable connector touches any conductive area, including the grounding, the patient might be electrocuted.
3. Do not allow the ECG electrode to touch the patient's heart directly. Doing so may lead to cardiac arrest.
  - \* The ECG unit is a type BF unit. It is not designed for direct contact with the heart.
4. Use commercially available ECG electrodes. The user is responsible for selection of appropriate ECG electrodes.
5. Remove the ECG electrodes from the patient before using devices such as electric scalpels, high-frequency therapy equipment, electrostimulators, or electric defibrillators. In addition, when using such devices, do not let ultrasound transducers, PCG microphones, or pulse wave sensors to come into contact with the patient. Doing so may result in the patient receiving a burn injury or an electric shock.

**⚠CAUTION:** Information derived from reference signals should be used purely for reference. Do not use the waveforms or other reference signal information for diagnosis or monitoring. Note also that in patients with cardiac pacemakers or implantable electrostimulators and in patients with arrhythmia, the heart rate may not be calculated correctly.

**NOTE:** Changing the lead type by changing the reference signal cable connections without using the ECG Lead function

1. The relationships between the lead wire colors of the reference signal cable and the electrode positions are described below.

For regions other than the USA

Electrode positions (lead I)

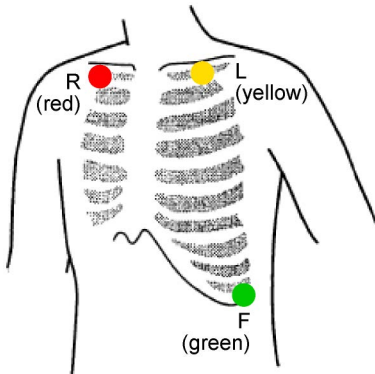

Three electrode leads  
Electrode positions

Symbol	Lead color (clip color)	Application position
R	Red	Right infraclavicular fossa
L	Yellow	Left infraclavicular fossa
F	Green	Lowest rib on the left anterior axillary line

To use lead II or lead III, connect the lead wires of the reference signal cable to the electrodes as shown below.

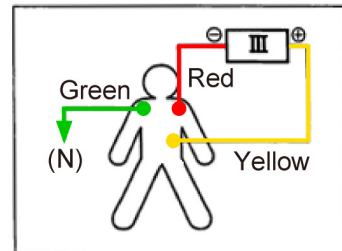
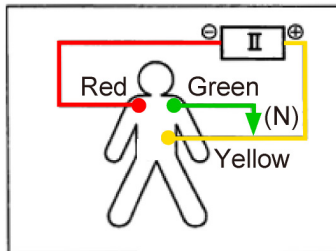
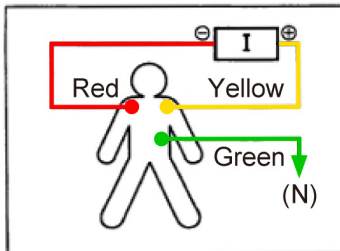

2. This system is designed to use ECG lead I. To use lead II or lead III, the lead colors and the connection destinations differ from the standard arrangement.

To display both the ECG waveform and the respiratory waveform (using the reference signal cable), use lead I.

**NOTE:** Changing the lead type by changing the reference signal cable connections without using the ECG Lead function

1. The relationships between the lead wire colors of the reference signal cable and the electrode positions are described below.

For the USA

Electrode positions (lead I)

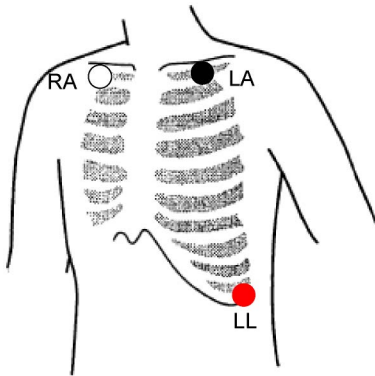

Three electrode leads  
Electrode positions

Symbol	Lead color (clip color)	Application position
RA	White	Right infraclavicular fossa
LA	Black	Left infraclavicular fossa
LL	Red	Lowest rib on the left anterior axillary line

To use lead II or lead III, connect the lead wires of the reference signal cable to the electrodes as shown below.

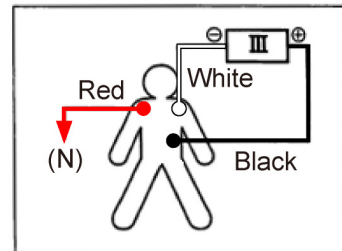
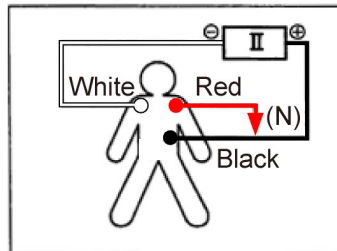
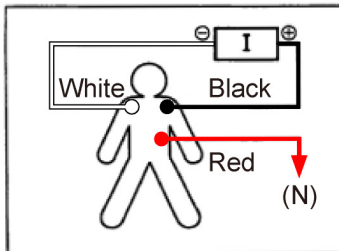

2. This system is designed to use ECG lead I. To use lead II or lead III, the lead colors and the connection destinations differ from the standard arrangement.

To display both the ECG waveform and the respiratory waveform (using the reference signal cable), use lead I.

## 12.1 Reference Signal Panel

- ⚠ CAUTION:**
1. Do not connect any medical device that is not fully compliant with IEC 60601-1 to [ECG DC IN] or [AUX]. Doing so may result in an electric shock.
  2. If external signals are to be input to [ECG DC IN] or [AUX], contact your TOSHIBA service representative. The signal input level is restricted.

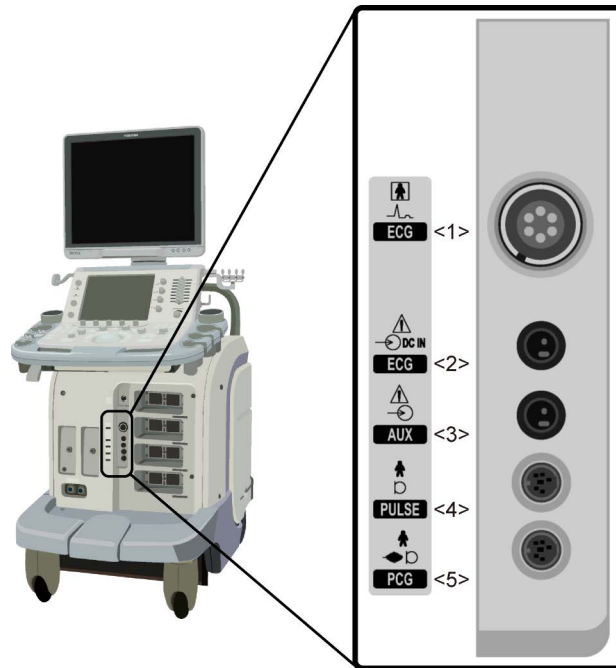

No.	Name	Function
<1>	<b>[ECG]</b> (patient)	Connector for ECG cord (this cord can also be used as an impedance respiratory sensor)
<2>	<b>[ECG DC IN]</b>	Connector for ECG signal input from an external monitor
<3>	<b>[AUX]</b>	Connector for signal input from an external device
<4>	<b>[PULSE]</b>	Connector for pulse wave sensor signal input
<5>	<b>[PCG]</b> (input)	Connector for heartbeat sensor signal input

## 12.2 Installing the Reference Signal Sensor

- (1) Connect the reference signal sensor cable to the reference signal panel while the system power is OFF.
- (2) Turn ON the power.
- (3) Set the sensor on the patient.

## 12.3 Adjusting Reference Signals

- (1) [PHYSIO] menu and reference signal display

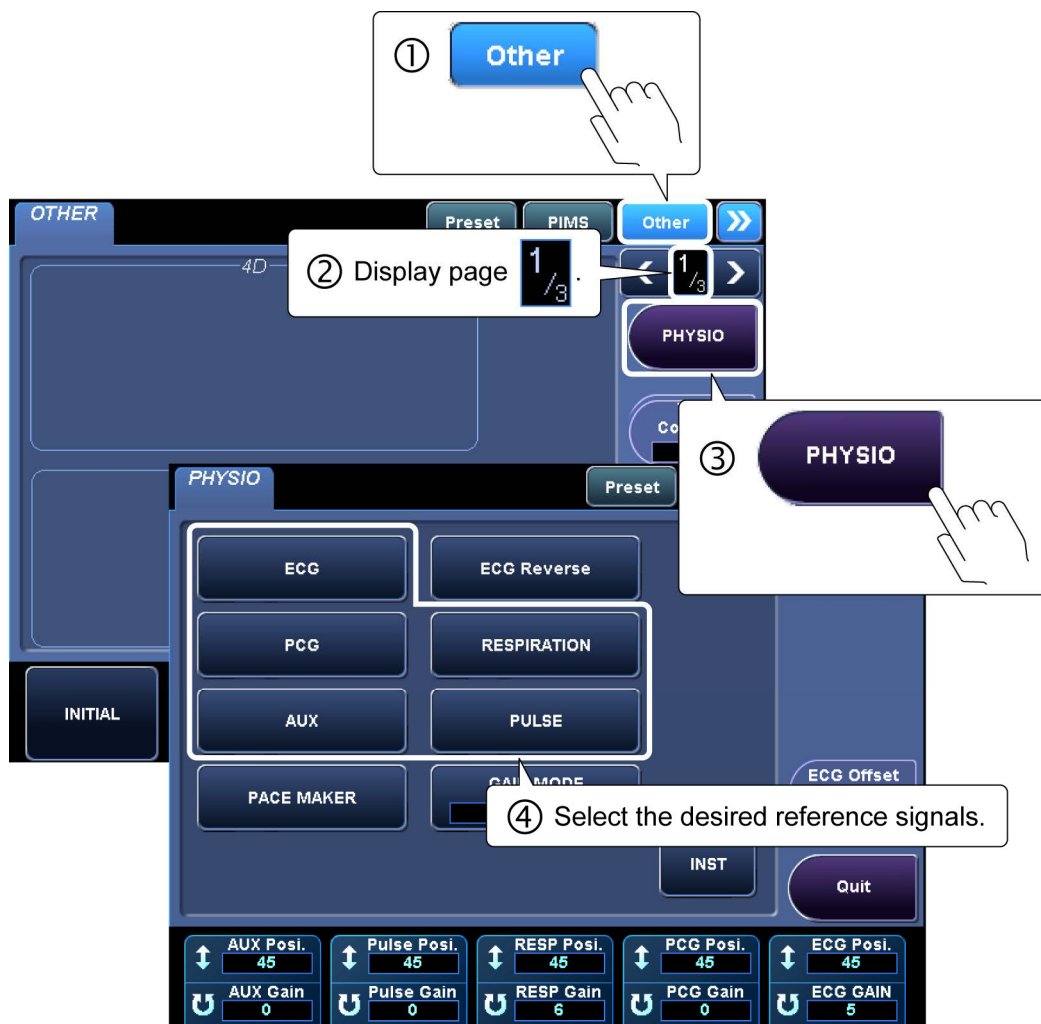

\* Up to two reference signals can be displayed simultaneously.

(2) Adjusting the reference signal display

The position of the waveform and the gain can be adjusted using the switches in the **[PHYSIO]** menu on the touch panel and the relevant knobs.

**[PHYSIO]** page 1/2



**[PHYSIO]** page 2/2













**NOTE:** **[PACE MAKER]** switch









1. When a patient with a cardiac pacemaker is examined, the pacing pulses generated by the pacemaker may be incorrectly recognized as the R-wave signals, and as a result, ECG gating or heart rate counting may not be performed correctly.

When the **[PACE MAKER]** switch is set to ON, the pacing pulses and R-wave signals can be distinguished, allowing ECG gating and heart rate counting to be performed based on the R-wave signals. However, even when the **[PACE MAKER]** switch is set to ON, ECG gating or heart rate counting may be performed based on the pacing pulses depending on the particular pacemaker or patient.

Diagnosis should be performed based on a comprehensive assessment of all available information, including the displayed waveforms.

2. When examining a patient with strong R waves, the system may mistakenly recognize these R waves as pacing pulses. If this is the case, set the **[PACE MAKER]** switch to OFF.

No.	Menu	Function
<1>		Used to turn the ECG waveform display ON/OFF.
<2>		Used to turn the PCG waveform display ON/OFF.
<3>		Used to turn the display of signals from external devices ON/OFF.
<4>		Used to avoid incorrect R-wave trigger detection due to the pacing pulses generated by a cardiac pacemaker (when examining patients with cardiac pacemakers).
<5>		Used to invert the ECG waveform. This switch is effective only in Real-time display mode.
<6>		Used to turn the respiratory signal display ON/OFF.
<7>		Used to turn the pulse signal display ON/OFF.
<8>		<p><b>[MANUAL]:</b> The gain of ECG, AUX, PULSE, RESP, or PCG (&lt;16&gt; to &lt;20&gt;) is adjusted individually.</p> <p><b>[AUTO]:</b> The gains of these signals are all adjusted at the same time. The <b>[ECG GAIN]</b> switch changes to <b>[AUTO GAIN]</b>, and the <b>[PCG Gain]</b>, <b>[RESP Gain]</b>, <b>[Pulse Gain]</b>, and <b>[AUX Gain]</b> switches are disabled.</p>
<9>		Used to reset the ECG waveform to the reference position when the ECG waveform is disturbed.
<10>		Used to adjust the baseline position of the ECG waveform.

No.	Menu	Function
<11>		Used to adjust the display position of the signal from the external device.
<12>		Used to adjust the display position of the peripheral pulse signals.
<13>		Used to adjust the display position of the respiratory signals.
<14>		Used to adjust the display position of the PCG waveform.
<15>		Used to adjust the display position of the ECG waveform.
<16> to <20>	<b>[AUX/Pulse/RESP/ PCG/ECG GAIN]</b>	Used to adjust the sensitivity of the displayed signal. This switch is effective only when <b>[MANUAL]</b> is selected for <b>[GAIN MODE]</b> .
<21>		Used to change the ECG lead type. Note that for the lead type to be changed correctly by this function, the electrodes must be applied as follows. For regions other than the USA Red : Right infraclavicular fossa Yellow : Left infraclavicular fossa Green : Lowest rib on the left anterior axillary line For the USA White : Right infraclavicular fossa Black : Left infraclavicular fossa Red : Lowest rib on the left anterior axillary line
<22>		Used to adjust the harmonic components of the phonocardiogram (0, 1, 2).
<23>		Used to close the menu.



# 13. Common Operation for Each Mode

## 13.1 Touch Panel Operation

**CAUTION:** Do not press two or more switches simultaneously. Doing so may cause a system malfunction.

In this system, it is possible to change the switch layout on the touch panel and the knob operating directions. It is also possible to add customized menus (touch panel customization). Customization is performed by service personnel. Contact your TOSHIBA service representative.

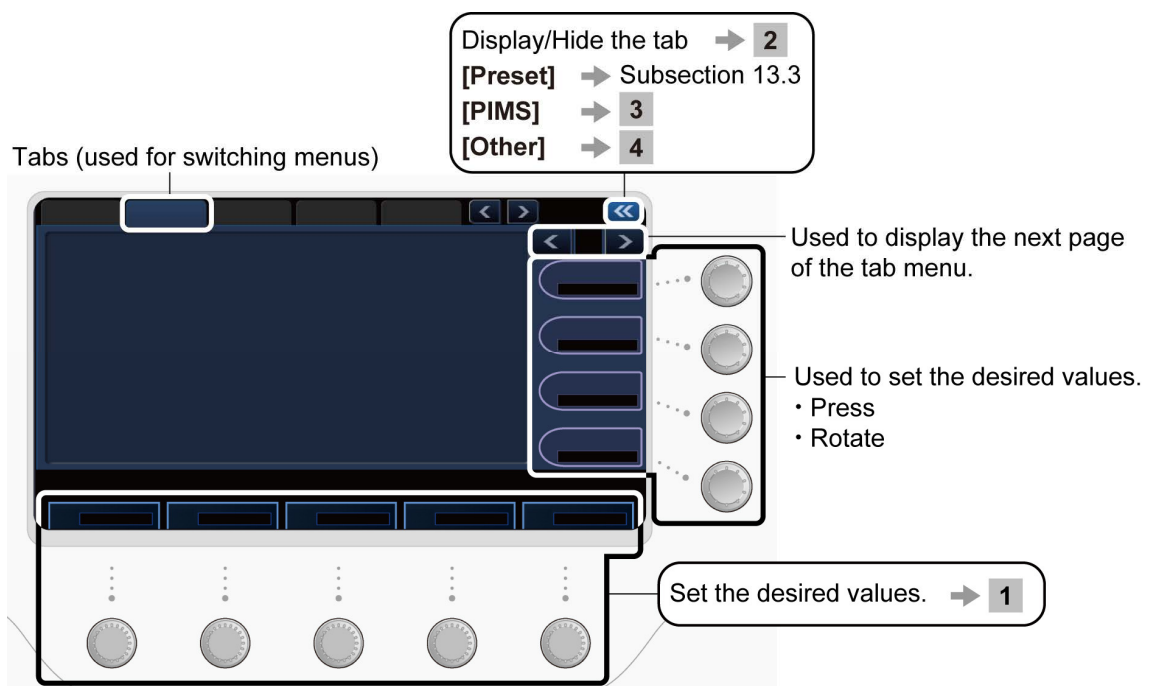

**NOTE:**

1. To enter another mode, press the corresponding mode switch on the main panel.
2. When several modes such as 2D, CDI, and PW are active at the same time, switch the tab to change the parameter as needed.
3. In Freeze mode, the switches that are disabled are grayed out.

## 1 Using the knobs

The knobs corresponding to the icons displayed in the function menus can be used for setting as explained below.

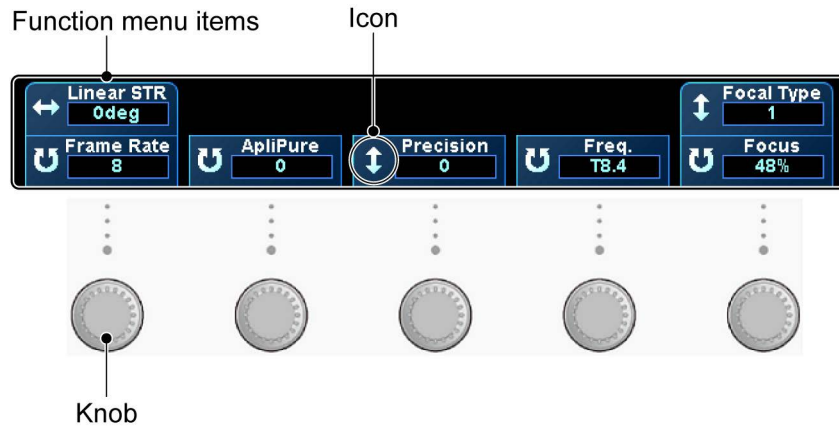









Icon	Knob operation direction
	Left/right
	Up/down
	Rotate

## 2 Tab functions

Tab	Function
	Includes presets which can be selected in order to change their settings.
	Includes menus related to image saving and printing.
	Includes optional functions and menus such those related to screen brightness and sound volume.



No.	Switch	Function
<1>		Turns the display of the <b>[Patient Registration]</b> screen ON/OFF.
<2>		Ejects the media from the CD/DVD unit.
<3>		Ejects the media from the peripheral unit.
<4>		Turns the display of patient information ON/OFF. It is possible to set the system not to display the patient information (patient ID, name, sex, age, name of the system used to acquire the data, date and time, hospital name). Refer to subsection 22.2.1 of the operation manual <<Applications volume>>.)
<5>		Turns the display of the <b>[Exam Review]</b> screen ON/OFF.
<6>		Disconnects USB flash drive.
<7>		Displays the video playback menu.
<8>		Used for full-screen printing.
<9>		Used to transfer data to the DICOM printer.

Refer to section 19 "Storing Image Data" for other functions provided in the PIMS menu.











Refer to section 19 "Storing Image Data".







4 Operations from the touch panel ([OTHER] tab menu)

[OTHER] page 1/3





No.	Switch	Function
<1>		Resets the settings of Scan Range, Color ROI, and Doppler range gate position in 2D mode or volume display in 4D mode to the initial values during measurement or imaging.
<2>		Displays the cursor on the monitor.
<3>		Used to select the image zooming method (Center or Spot). * Refer to subsection 14.1.4 for details.
<4>		Displays the <b>[PHYSIO]</b> menu.
<5>		Used to adjust the brightness and contrast of the touch panel. * Press the corresponding knob to toggle the label of this switch between <b>[TCS Brightness]</b> and <b>[TCS Contrast]</b> .
<6>		Used to adjust the volume and tone of the beep that is output when a switch on the main panel is pressed. * Press the corresponding knob to toggle the label of this switch between <b>[Panel Beep Volume]</b> and <b>[Panel Beep Tone]</b> .
<7>		Used to adjust the volume and tone of the beep that is output when a printing, storage, or video recording operation is performed. * Press the corresponding knob to toggle the label of this switch between <b>[Output Beep Volume]</b> and <b>[Output Beep Tone]</b> .
<8>		Switches the exam image display area on the monitor (normal/expand).

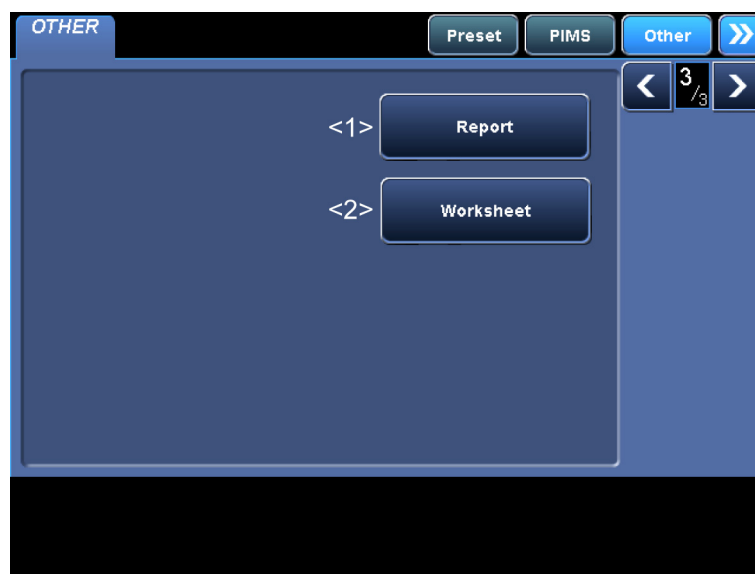

No.	Switch	Function
<1>		Updates the gain offset values set with the STC sliders during Quick Scan.
<2>		Resets the gain offset values updated using [ <b>Q. Scan Comp Update</b> ] to the values immediately after Quick Scan was started.
<3>		Displays the angle icon for the M-TEE transducer. * This switch is displayed when an M-TEE transducer is connected to the system.
<4>		Displays the [ <b>Maintenance</b> ] menu.
<5>		Displays the menu for setting the presets.
<6>		Saves the error messages and abnormal images. (This switch should be pressed when an error message or an abnormal image is displayed.)



No.	Switch	Function
<1>		Starts up the <b>[Report]</b> screen.
<2>		Starts up the <b>[Worksheet]</b> screen.

## 13.2 Trackball Functions

Functions corresponding to the system status are assigned to the trackball.

### 13.2.1 Trackball function area

The icon indicating the function currently assigned to the trackball (function icon) is displayed on the monitor.

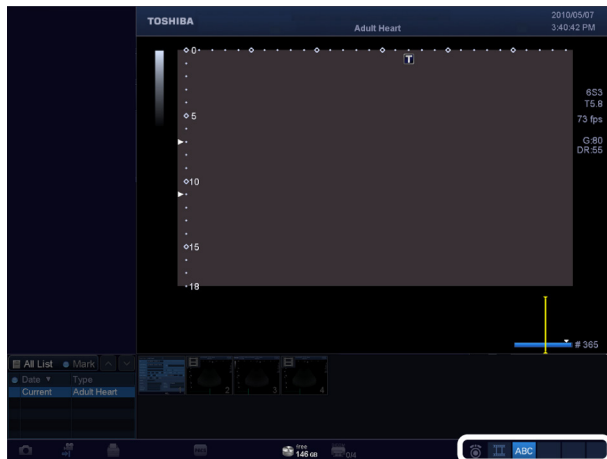

Trackball function area

<<Trackball function icons>>



: Cine control



: Annotation control



: Body mark control



: ROI movement



: ROI size change



: Sampling gate control





: Cursor control

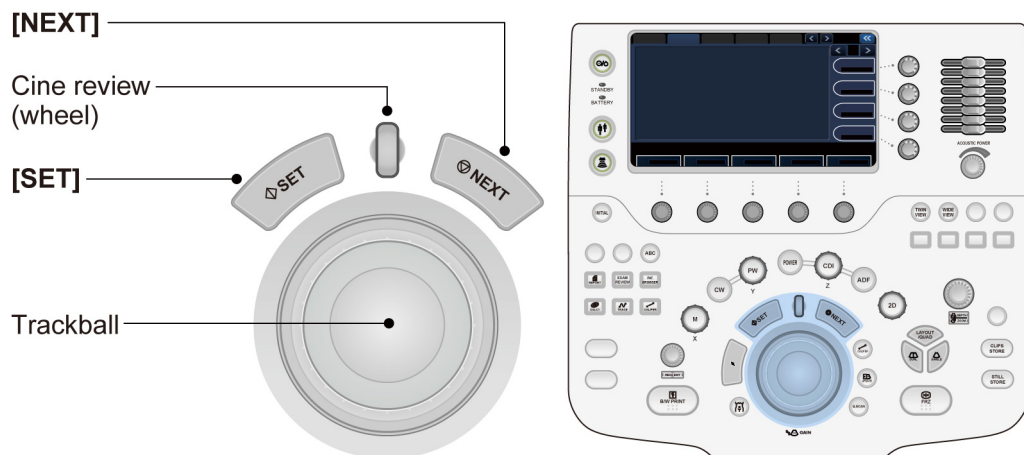

## 13.2.2 Trackball operations



- 1 When multiple functions are available

Press  or  to select the function to be used.

- 2 To assign a function to the trackball that is not shown in the trackball function area

Directly press the switch for the desired function.

- 3 To set the trackball back to the cine control function

 Press the wheel.

- 4 To perform measurement

Directly press the switch for the desired function.

## 13.3 Selecting an Imaging Preset During Examination

Imaging preset: Preset of the parameters related to image quality

- 1 To select an imaging preset

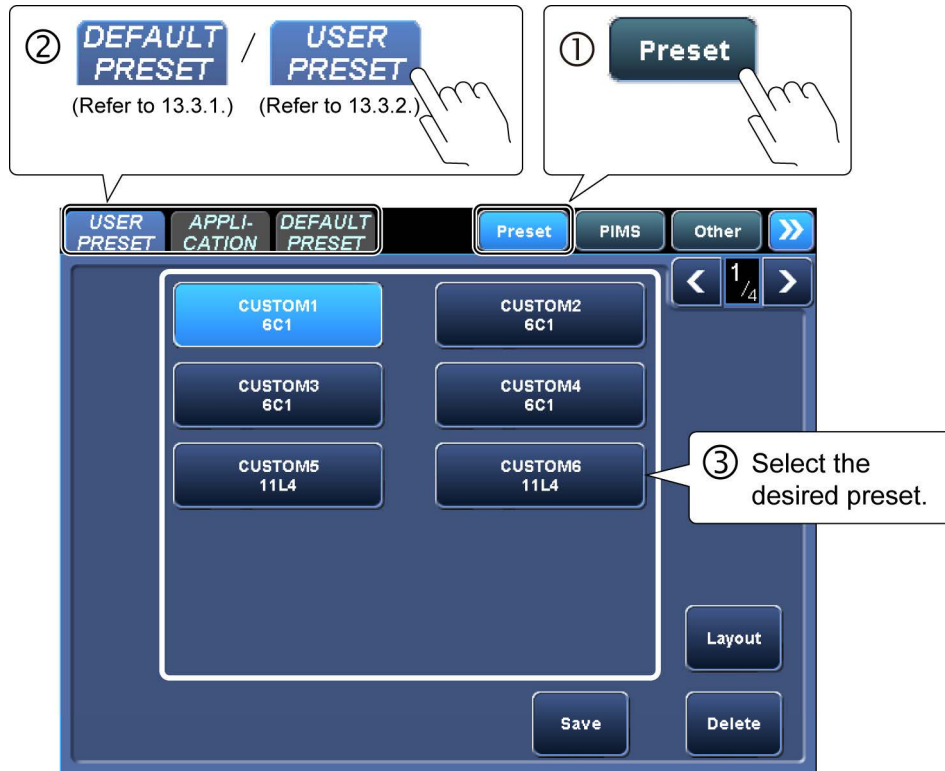

- 4 The transducer registered to the preset is selected automatically.  
If the registered transducer is not connected to the system, the transducer selection menu is displayed on the touch panel.  
Select the transducer.

- 2** To change the image quality conditions for the currently active mode (sub-preset) only
- 

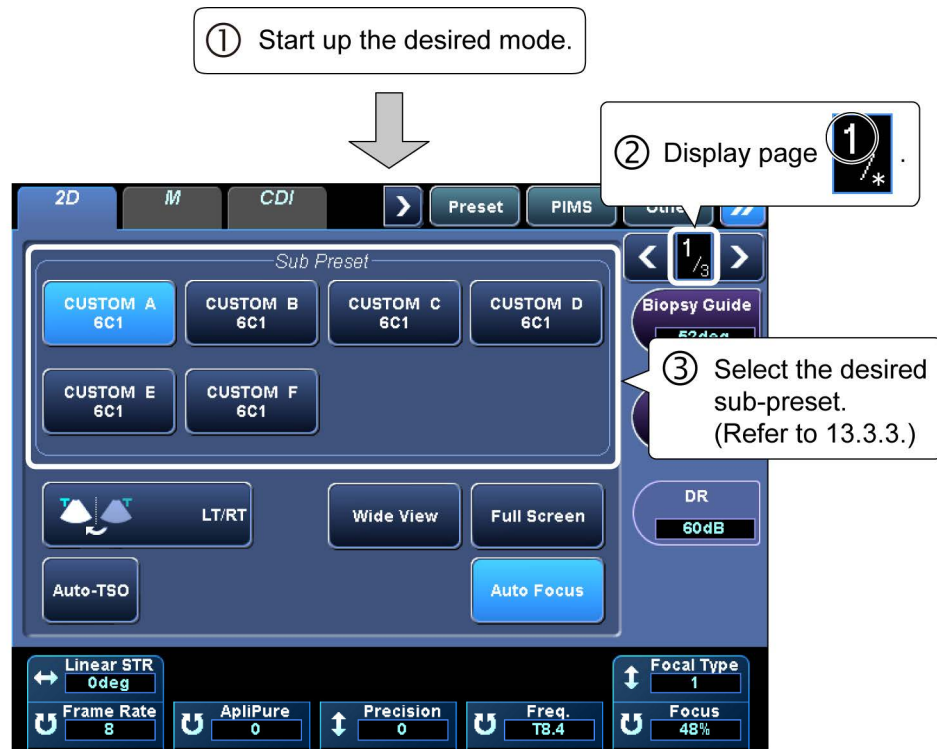

- 3** Switch displays
- 

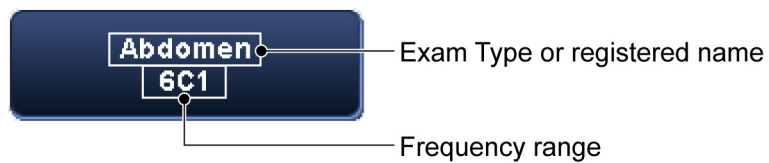

### 13.3.1 [DEFAULT PRESET] tab

Imaging presets with default settings (factory defaults) can be selected.

[DEFAULT PRESET] page 1/3



No.	Exam type	Description
<1>	<b>[Abdomen]</b>	Abdomen general
<2>	<b>[OB]</b>	Obstetrics
<3>	<b>[Prostate]</b>	Prostate gland
<4>	<b>[PV Arterial]</b>	Peripheral vessel (artery)
<5>	<b>[Neo-Head]</b>	Infant head
<6>	<b>[Neo-Hip]</b>	Infant hip joint
<7>	<b>[Endo-Vaginal]</b>	Endovaginal
<8>	<b>[Digits]</b>	Peripheral vessel (of finger)
<9>	<b>[Neo-General]</b>	Infant abdomen general
<10>	<b>[Fetal Heart]</b>	Fetal circulation



No.	Exam type	Description
<1>	<b>[GYN]</b>	Gynecology
<2>	<b>[Testes]</b>	Testis
<3>	<b>[Adult Heart]</b>	Circulatory system general
<4>	<b>[Coronary]</b>	Coronary artery
<5>	<b>[Breast]</b>	Breast
<6>	<b>[Kidney]</b>	Kidney
<7>	<b>[PV Venous]</b>	Peripheral vessel (Vein)
<8>	<b>[Pediatric Heart]</b>	Pediatric circulatory system
<9>	<b>[TCD]</b>	Transcranial Doppler
<10>	<b>[Thyroid]</b>	Thyroid gland



No.	Exam type	Description
<1>	<b>[Carotid]</b>	Carotid artery
<2>	<b>[OTHER]</b>	Other
<3>	<b>[MSK]</b>	Orthopedics
<4>	<b>[M-TEE]</b>	Transesophageal

### 13.3.2 [USER PRESET] tab

The presets that were created and registered by adjusting image parameters (user presets) can be selected on the **[USER PRESET]** tab.

For details on registering and deleting user presets, refer to the operation manual Applications volume, subsection 21.1.

<<Example>>

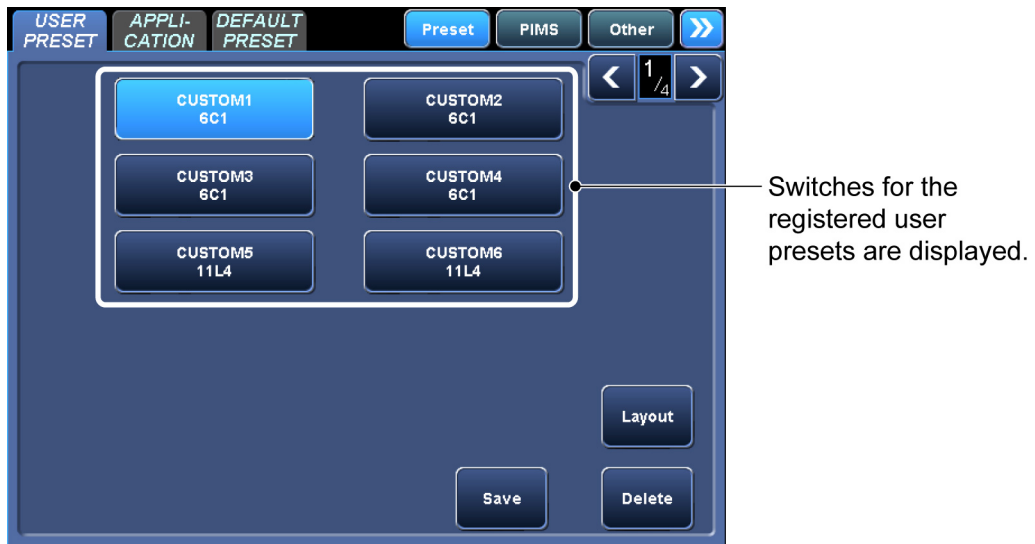

### 13.3.3 [Sub Preset] menu

The registered sub-presets can be selected in the **[Sub Preset]** menu. Only the presets for the currently active mode can be selected.

For details on registering and deleting sub-presets, refer to the operation manual Applications volume, subsection 21.2.

<<Example>>



## 13.4 Selecting an Application Preset During Examination

Application preset: Preset of conditions for measurement, body mark, comment entry, and report

- 1 Selection from the [**Preset**] tab menu

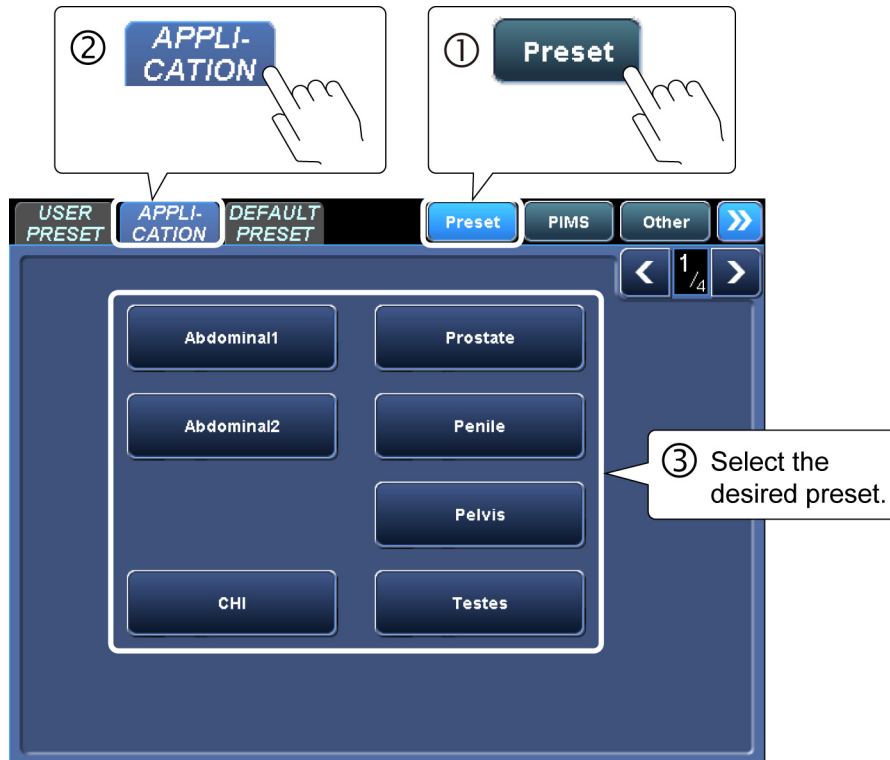



## 2 Application presets

The supported functions for each application preset are shown below.

Application preset	Application measurement	Annotation	Body mark
<b>[Abdominal 1]</b>	N/A (user registration is available)	Abdominal	Abdominal/General
<b>[Abdominal 2]</b>	N/A (user registration is available)	Abdominal	Abdominal/General
<b>[CHI]</b>	N/A (user registration is available)	CHI	Abdominal
<b>[Prostate]</b>	N/A (user registration is available)	Prostate	Testis/Prostate
<b>[Penile]</b>	N/A (user registration is available)	PV Lower	Testis/Prostate
<b>[Pelvis]</b>	N/A (user registration is available)	Pelvis	Body/Legs/OB
<b>[Testes]</b>	N/A (user registration is available)	Testis	Testis
<b>[PV Upper]</b>	N/A (user registration is available)	PV Upper	PV Upper/PV Lower
<b>[PV Lower]</b>	N/A (user registration is available)	PV Lower	PV Upper/PV Lower
<b>[Carotid 1]</b>	Vascular (user registration is available)	Carotid	Carotid
<b>[Carotid 2]</b>	N/A (user registration is available)	Carotid	Carotid
<b>[Thyroid]</b>	N/A (user registration is available)	Thyroid	Neck/Mammo
<b>[TCD]</b>	N/A (user registration is available)	Neonatal Head	Head
<b>[MSK]</b>	N/A (user registration is available)	MSK	Body
<b>[OB/Gyn]</b>	OB/Gyn	OB/Gyn	OB/Gyn
<b>[Neo-Hip]</b>	N/A (user registration is available)	Neo-Hip	Legs
<b>[Breast]</b>	N/A (user registration is available)	Breast	Mammo
<b>[Heart 1]</b>	Cardiac (user registration is available)	Heart	Cardiac
<b>[Heart 2]</b>	Cardiac (user registration is available)	Heart	Cardiac
<b>[Heart 3]</b>	N/A	Heart	Cardiac

## 13.5 Changing the Transducer During Examination

- CAUTION:**
1. Be sure to turn OFF the power or select another transducer connector before connecting a transducer to or disconnecting the transducer from the currently selected transducer connector. Connecting a transducer to or disconnecting the transducer from the currently selected transducer connector can cause damage to the system or the transducer.
  2. Do not connect or disconnect a transducer during system startup or shutdown. Doing so may cause a malfunction.

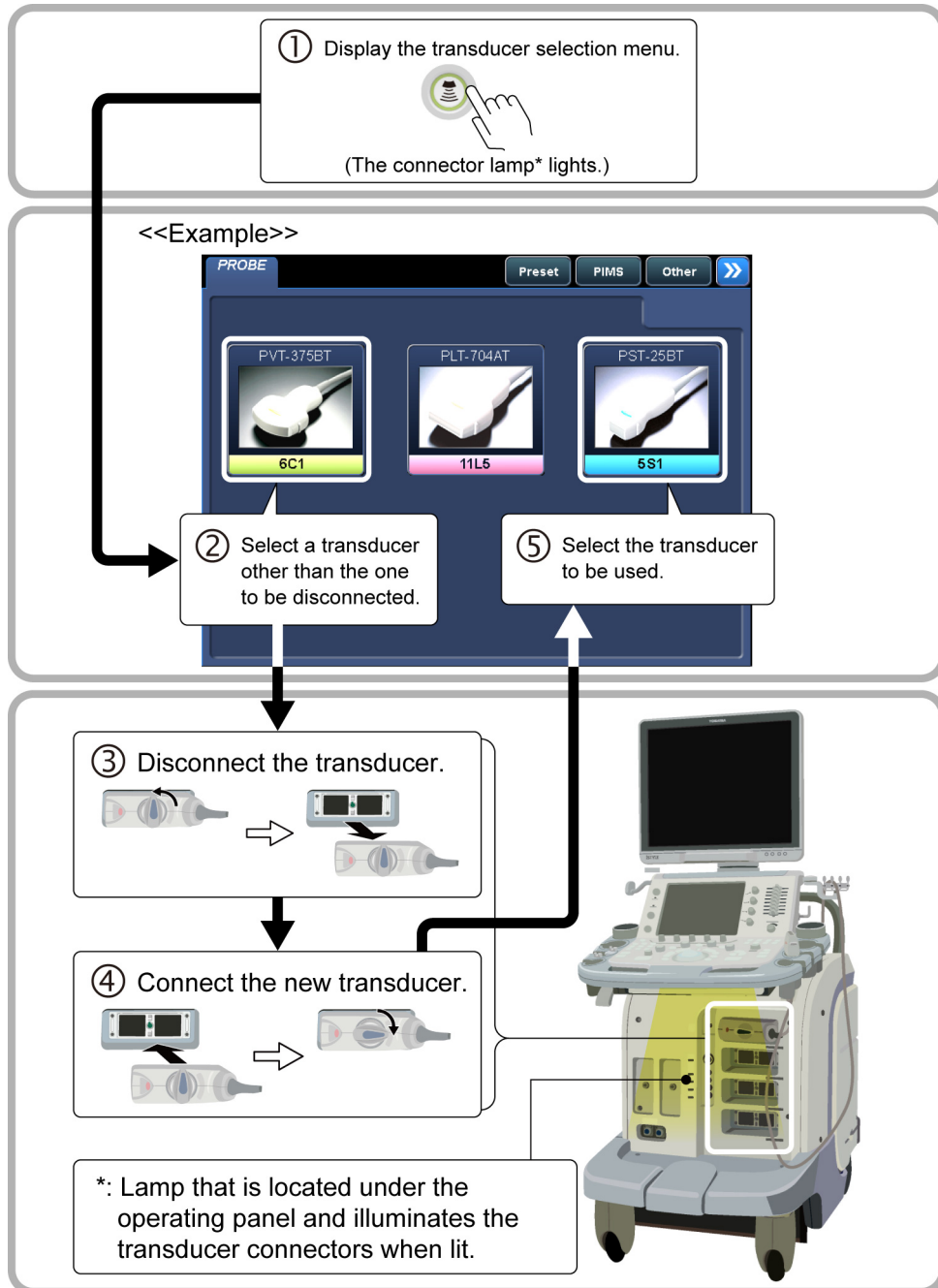

**NOTE:** The connector lamp goes out when the transducer selection menu is closed when another switch is selected.

# 14. Display and Operation in Each Mode

**NOTE:** The switches displayed on the touch panel, the switch layout, and the number of tabs differ depending on the selected mode, exam type, and transducer. For details of switch display, contact your TOSHIBA service representative.

## 14.1 2D Mode

Press  to display images in 2D mode (real-time 2D).

### 14.1.1 2D display layout

<<Display example>>

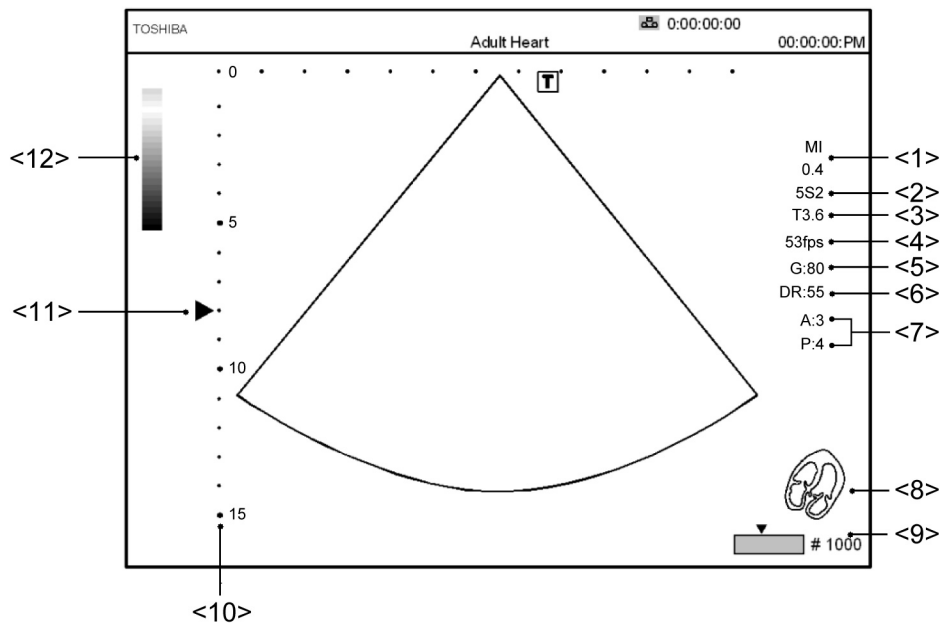

No.	Displayed item
<1>	MI (mechanical index) value
<2>	Transducer being used (type and frequency band of the transducer) <<Transducer type >> [S]: Sector transducer, [C]: Convex transducer [L]: Linear transducer, [P]: Pencil transducer
<3>	Current frequency [T]: THI (Filter/PS), [H]: CHI, [diffT]: differential THI
<4>	Frame rate
<5>	2D gain
<6>	2D dynamic range
<7>	Index of image quality adjustment [A]: ApliPure, [P]: Precision, [T]: Tissue Enhancement
<8>	Body mark
<9>	2D Cine icon
<10>	Depth scale mark The scale mark intervals change according to the depth.
<11>	Focus mark
<12>	Gray scale bar

## 14.1.2 Adjustment using the main panel

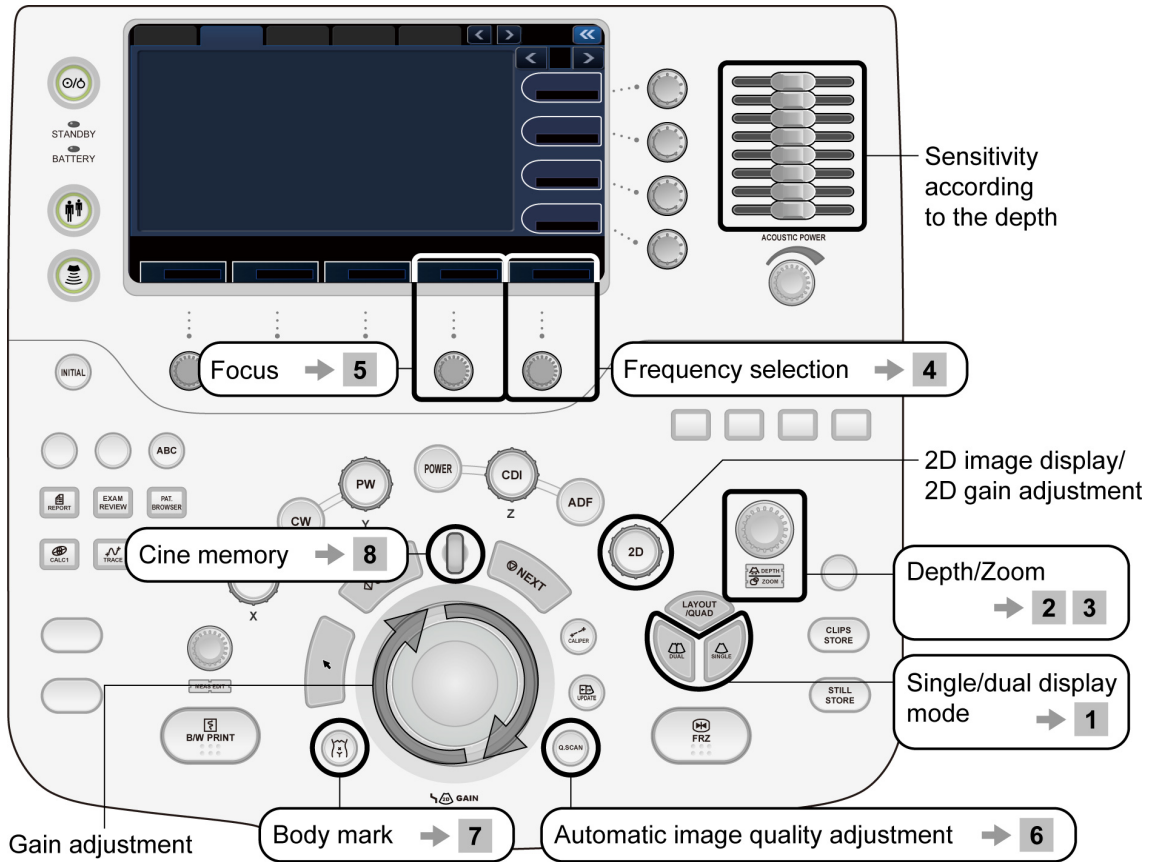

### 1 Displaying the dual display mode screen



Displays the dual display mode screen.

This switch toggles the real-time display between the two frames.

The **T** mark is highlighted in the frame in which the real-time image is displayed.

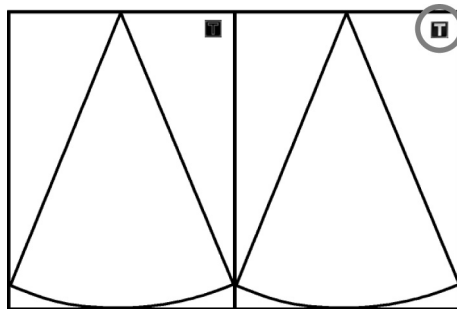

Returns to the single display mode screen.

**NOTE:**



is pressed to return to 2D single display mode directly from another imaging or display mode. Even if the image is frozen, when this switch is pressed, the image is unfrozen and displayed in 2D single display mode.



is pressed to return to single display mode from dual display mode, update display mode, or full display mode.

**2** Adjusting the depth



Clockwise : Shallower

Counterclockwise : Deeper



\* When the **[ZOOM]** LED is lit, press the dial to light the **[DEPTH]** LED.

**3** Image zooming/panning/movement (PAN/ZOOM)



Press this dial to set zoom mode (the **[Zoom]** LED lights). Image zooming and panning becomes possible.



The image zooming method can be selected using the **[Zoom Method]** switch in the **[OTHER]** menu (refer to subsection 14.1.4).

**4** Changing the frequency



Use the **[Freq.]** knob to change the frequency.

The current frequency is shown on the image.

**5** Changing the focus



Use the **[Focus]** knob to change the focal position (the focus mark is changed from **[▶]** to **[>]** and **[Auto Focus]** is turned OFF).

- The focal position set using this switch is maintained even when the depth is changed after the focal position is changed.
- When the focal position is outside the depth, it is reset to the initial position **[Auto Focus]** ON.

## 6 Adjusting the image quality automatically (2D mode quick scan)

---



When this switch is pressed (single click), the following parameters are adjusted automatically.

- STC (gain in the depth direction)
- 2D gain (overall gain)
- Lateral gain (gain in the scanning direction)

Press  twice in succession (double click) to terminate quick scan.

Refer to subsection 14.1.5 "2D mode quick scan" for details.

## 7 Displaying the body mark

---



Press this switch to display the body mark (refer to section 16 "Body Mark" for details).

## 8 Displaying previous frames

---



After the image is frozen, Cine image operations can be performed.

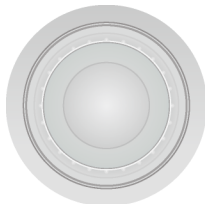













The previous frames can be displayed using the trackball (refer to section 15 "Cine Function" for details).









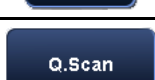





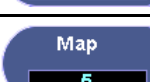

In Body mark or Annotation mode, press the wheel to change the icon indicating the function assigned to the trackball.

### 14.1.3 Adjustments using the touch panel





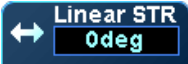





<<Display example>> Exam Type: **[Abdomen]**, Transducer: PLT-704AT

Switch	Function
<b>[Sub Preset]</b>	Displays created sub presets.
	Switches the exam image display area on the monitor (normal/expand).
 *1	Starts Trapezoid scan.
	Reduces speckle noise when Apure <sup>+</sup> is ON.
	Flips the image horizontally.
	Flips the image vertically.
	Displays monochrome and color images simultaneously in real-time.
	Turns the M/D cursor display ON/OFF in single display mode.
	Used to automatically turn OFF ApliPure+ processing for the 2D image in the background in color mode.
	Displays the time elapsed after this switch is pressed.
	Starts TDI mode.
	Turns ON the automatic reception focus compensation function (Auto-TSO).
	Turns Auto-TSO OFF.
	Turns Quick Scan ON.

Switch	Function
	Turns Quick Scan OFF.
	Used to adjust image quality automatically and perform automatic compensation for the reception focus simultaneously.
	Used to select the 2D image size. <b>[General]</b> or <b>[Large]</b> can be selected.
	Adjusts the image quality of the zoomed image.
	Optimizes the focal position automatically.
	Used to display the needle mark (for details, refer to section 18 "Needle Mark").
	Used to select the type of THI mode for 2D images. After pressing this switch, use the corresponding knob to select the mode from among <b>[Fund]</b> , <b>[PS]</b> , <b>[Filter]</b> , and <b>[Diff]</b> .
	Used to adjust the scan range for the 2D image.
	Used to adjust the color of the images.
	Used to adjust the gamma curve.
	Used to adjust the dynamic range.
	Used to select the needle mark size.
 <sup>*2</sup>	Used to adjust the sensitivity for the deeper areas and frame rate.
	Used to adjust the gain in the lateral direction of the image.
  <sup>*3</sup>	Steers the 2D image left and right.  (For scanning with a convex or sector transducer, this function is effective only when the viewing angle is limited using the <b>[Scan Range]</b> function.)
	Used to move the focus position.
	Used to select the frequency for the 2D image. Generally, a higher frequency is used to acquire images with higher resolution, while a lower frequency used to increase penetration in order to image deeper regions.



Switch	Function
 Focal Type 1	Used to select the ultrasound beam focus (number of focal steps etc.).
 T.E. 0 <sup>*4</sup>	Used to enhance the tissue signal in 2D images. (Tissue Enhancement)
 TSO 0	Used to perform compensation for the reception focus.
 AGC 0	Used to adjust the degree of suppression of trails and noise.
 Precision <sup>*5</sup> 0	Used to adjust the image quality using the Precision Imaging function.
 Frame Rate 8	Used to adjust the image density and the frame rate (number of frames).
 Persist. 4	Used to adjust the image smoothness.
 E.E. 1	Used to adjust the degree of image edge enhancement.
 ApliPure 0	Used to adjust the image quality using the ApliPure™ function.

\*1: Available when a linear transducer is selected.

\*2: Available when the PLT-704SBT or PVT-674BT is selected.

\*3: Available when a linear transducer is selected and ApliPure<sup>+</sup> is OFF.

\*4: Available when a sector transducer is selected.

\*5: Available when a transducer other than a sector transducer is selected.

## 14.1.4 Selection of image zooming method

The image zooming method can be selected using the **[Zoom Method]** switch in the **[OTHER]** menu. When the Zoom mode is ON, however, the **[Zoom Method]** switch cannot be operated.

### 1 Zooming the image around the center of the image (Center Zoom)

---

(1) Confirm that "Center" is displayed on  in the **[OTHER]** menu (the initial setting is "Center").

(2) Zoom the image.

(a) Zoom the image.



: Rotate the dial.

(b) Pan the image.



: Operate the trackball.

(3) Pressing the **[DEPTH/ZOOM]** dial again resets the panning/zooming operation and returns the image to the depth (size) that was set before the image was zoomed.

---

## 2 Zooming the specified portion of the image (Spot Zoom)

- \* This function is available when the selected transducer is not a linear transducer.
- \* The zoom guide is not displayed in Quad (four-frame) display mode or M/Doppler mode.

(1) Display "Spot" on the  switch in the **[OTHER]** menu.

(2) Rotate the **[DEPTH/ZOOM]** dial to display the zoom ROI on the image.

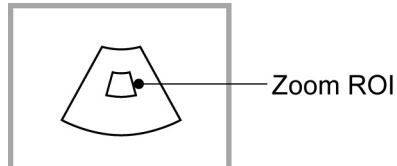



(3) Move the zoom ROI to the area to be zoomed.

(a) Moving the zoom ROI

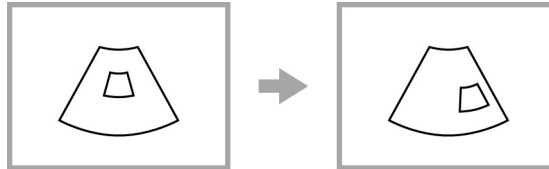
Use the trackball when the function icon appears .



(b) Changing the zoom ROI size

Press  to change the function icon to .

Use the trackball to change the ROI size. Press  to set the ROI size.

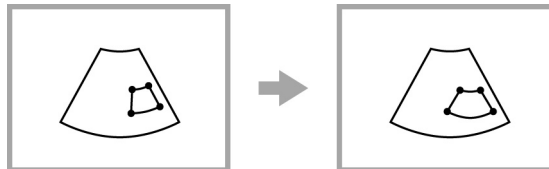

\* The size of the zoom ROI can also be changed by rotating the **[DEPTH/ZOOM]** dial.

(4) Rotate the **[DEPTH/ZOOM]** dial.  
The zoom guide is displayed at the top right of the screen and the portion of the image inside the zoom ROI is zoomed.

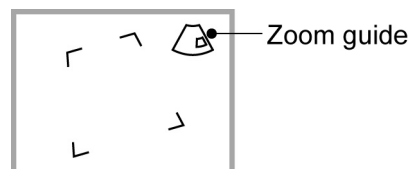

(5) Pressing the **[DEPTH/ZOOM]** dial again terminates Spot Zoom mode and returns the image to the depth (size) that was set before the image was zoomed.

## 14.1.5 2D mode quick scan

The quick scan function automatically adjusts the image quality. This function is available only when the 2D mode image is displayed in real time. Note that automatic update (Auto update) and exit (Quit) cannot be executed for quick scan in the following cases.

- In M mode or MDF-only mode

### 1 Operating procedures

---

Quick scan ON : Press .

Quick scan OFF : Press  twice in succession (double click) or press



### 2 Automatic adjustment of gain adjustment parameters

---

When  is pressed, the following gain adjustment parameters are automatically adjusted.

- STC (gain in the depth direction)
- 2D gain (overall gain)
- Lateral gain (gain in the scanning direction)

The change in the 2D gain is temporarily stored as an offset. Press  again to add this offset. When quick scan is exited, this offset is reset.

### 3 Automatic updating of image quality set values

---

If either of the following operations is performed during quick scan , the image quality set values are automatically updated.

- Releasing freeze status
- Changing depth
- Changing parameters of either of the following switches





Note that it is possible to enable/disable (turn ON/OFF) the automatic update function from the [Preset] menu (refer to the operation manual Application volume, subsection 22.2.1, for details). The automatic update function is OFF by default.

---

## 4 STC setting and automatic update function setting

---

- (1) The STC slider positions when  is pressed are set as the center values for the adjustment ranges. The movement range over which adjustment is possible depends on the position when  is pressed as illustrated in the figures below.

Adjustment range when the sliders are at the center

Movement range over which adjustment is possible

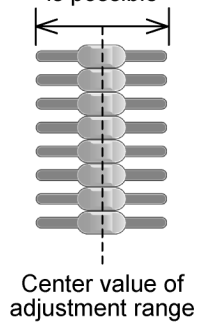

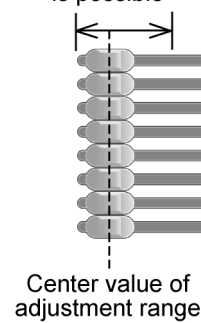

Example of adjustment range when the sliders are not at the center

Movement range over which adjustment is possible



- (2) The changed offset can be saved or reset using the following switch in the **[OTHER]** menu on the touch panel:

 : Saves the offset.

 : Returns the saved offset to the original setting.

- (3) Quick scan is automatically updated when any changes are made to the STC settings. Note that the automatic update function can be disabled from the **[Preset]** menu (refer to the operation manual Applications volume, subsection 22.2.1, for details).

If automatic updating is disabled, the changed STC settings are valid until

 is pressed.

---

## 14.1.6 Trapezoid scan

- 1 When a linear transducer is used
- 

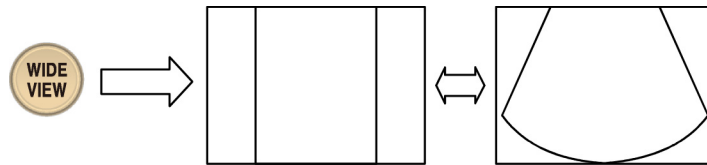

Each time the **[WIDE VIEW]** switch is pressed, the display toggles between normal display and trapezoid display.

Note that when this switch is operated, the depth and other such settings are reset to their default values.

- 2 When a sector transducer (other than the TEE transducer) is used
- 

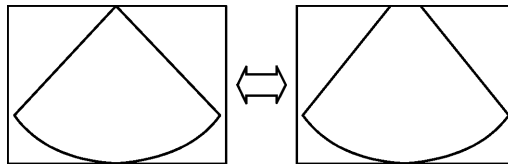

Trapezoid scan is automatically activated for the following exams (imaging presets).

- **[Abdomen]**
  - **[Pv-Art]**
  - **[NeoGen]**
  - **[NeoHead]**
  - **[Kidney]**
  - **[TCD]**
-

## 14.2 M Mode

Press  to display images in 2D+M mode.

2D display mode can be changed to 2D+M display mode by pressing .

### 14.2.1 M display layout

<<Example layout>>

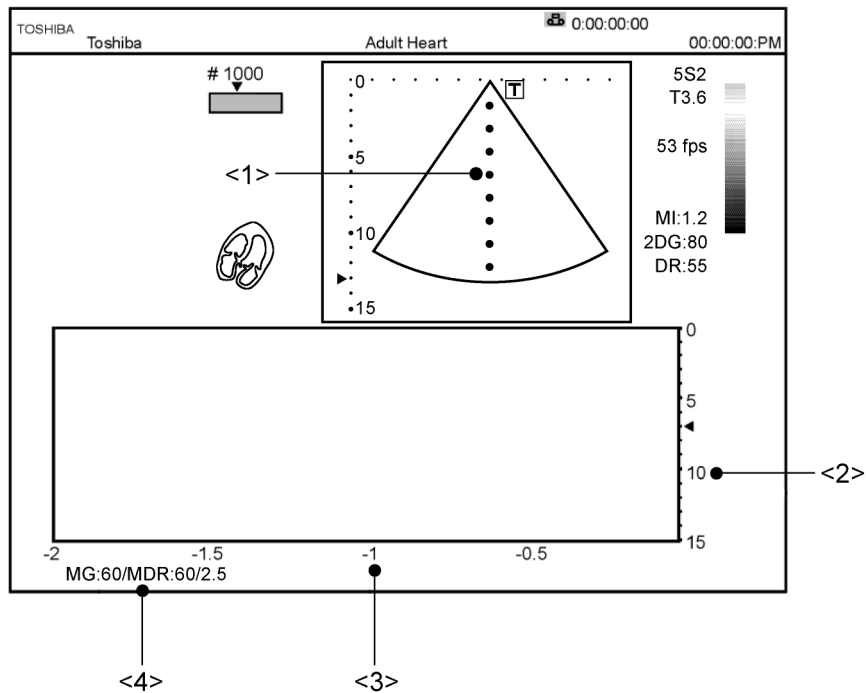

No.	Displayed item
<1>	M cursor
<2>	M depth scale mark
<3>	Time scale
<4>	M gain ( <b>[MG]</b> ) M dynamic range ( <b>[MDR]</b> ) M transmission/reception frequency

## 14.2.2 Adjustment using the main panel

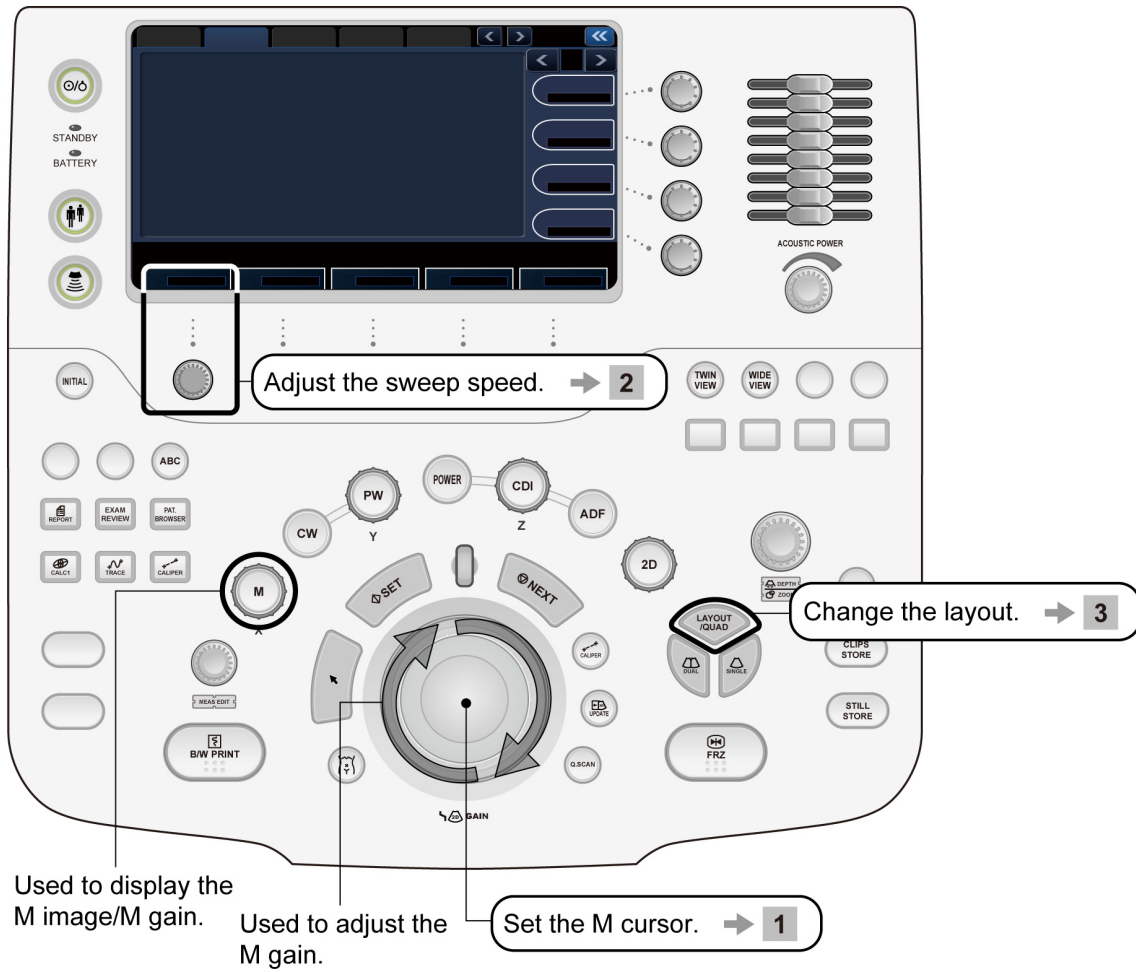

### 1 Setting the M cursor

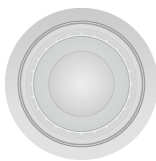

On the 2D+M screen, the trackball can be used to move the M cursor.

\* In 2D mode, pressing  displays the 2D+M screen.

### 2 Changing the display speed of the waveform

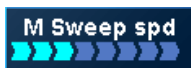

Use the **[M Sweep speed]** knob to adjust the display speed.



### 3 Changing the display layout



This switch can be used to cycle through the available display layouts. Each time the switch is pressed, the display layout changes to the next one in a predetermined order.

Pressing  on the touch panel allows the display layout to be selected directly from the pull-down menu.

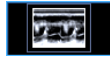

Full (available only when the image is frozen)

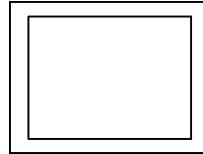

Side by side

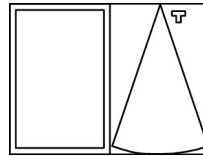

Up/Down 2/3

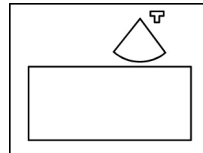

Up/Down 1/2

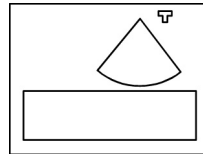



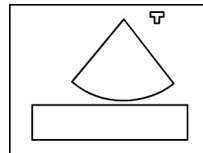



Up/Down 1/3

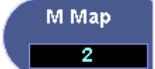

### 14.2.3 Adjustment using the touch panel



<<Display example>> Exam Type: **[Adult Heart]**, Transducer: PST-25BT

Switch	Function
	Displays the dialog for the 2D+M display layout selection. Refer to <b>3</b> of subsection 14.2.2 "Adjustment using the main panel".
	Used to adjust the color of the M-mode image.
	Used to adjust the gamma curve.
	Used to adjust the sweep speed for the M-mode image.
	Used to adjust the degree of image edge enhancement.
	Used to adjust the degree of suppression of trails and noise.
	Used to adjust the dynamic range.

**NOTE:** Auto-data display for CDI/MCDI dual display

In CDI/MCDI mode, the values related to the images are automatically displayed on both the CDI image and the MCDI image (auto-data display). These values reflect the most recent changes to image settings.

For example, when the CDI image is a real-time image and the MCDI image is a frozen image, if the settings of the CDI image are changed, the auto-data for the frozen MCDI image is also changed. The values differ from the setting values at the time of freezing the MCDI image. When saving images, pay attention to this.

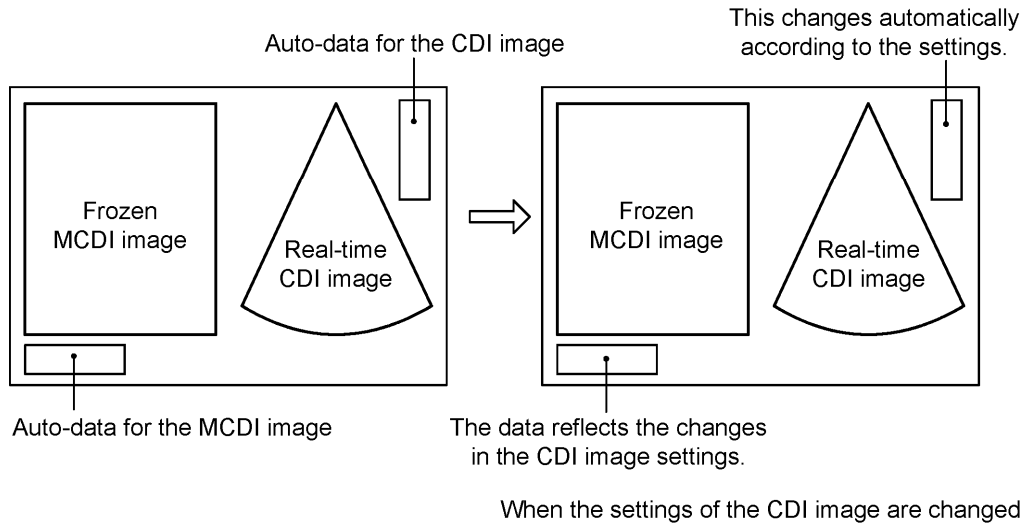

## 14.2.4 FLEX-M mode

In FLEX-M mode, M-mode image for any desired plane set on the 2D-mode image can be displayed.

\* To use FLEX-M mode, the optional USXM-A500A is required.

Operate as follows to enter FLEX-M mode.

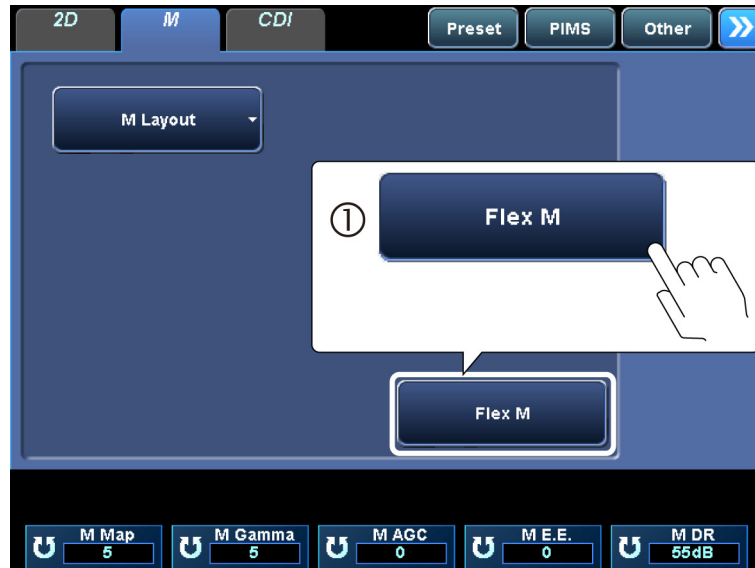

### 1 Image display in FLEX-M mode

<<Example for Up/Down 1/2 display mode>>

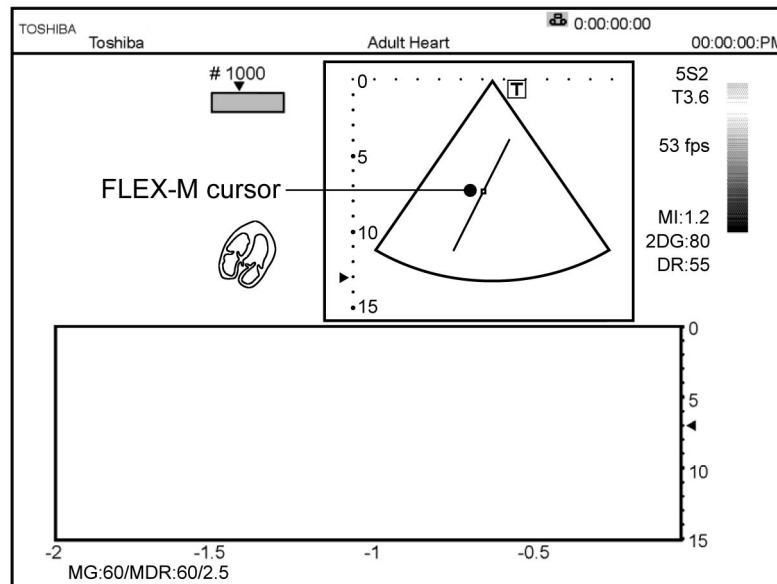



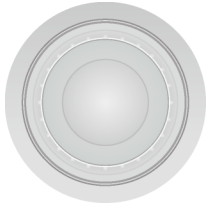

## 2 Moving the FLEX-M cursor



Operate the trackball to move the FLEX-M cursor to the desired position.

## 3 Adjusting the angle and position of the FLEX-M cursor

Switch	Function
	Angle adjustment
	Length adjustment
	Horizontal shift (effective only when the image is frozen)
	Vertical shift (effective only when the image is frozen)

- NOTE:**
- M gain adjustment**  
In FLEX-M mode, an M-mode image is reconstructed from a 2D-mode image. Therefore, it is not possible to change the gain of the M-mode image independently of the 2D-mode image.
  - Length of the FLEX-M cursor**  
The length of the FLEX-M cursor can be adjusted. The length of the FLEX-M cursor corresponds to the vertical axis scale of the M-mode image display area.
  - The FLEX-M cursor length displayed on the  switch is changed in cm. Even when the dial corresponding to this switch is rotated, the displayed value does not change if the change in the cursor length is less than 1 cm.

## 14.3 CDI Mode

The blood velocity information can be displayed in CDI mode.

Press  to display images in CDI mode.

### 14.3.1 CDI display layout

<<Example layout>>

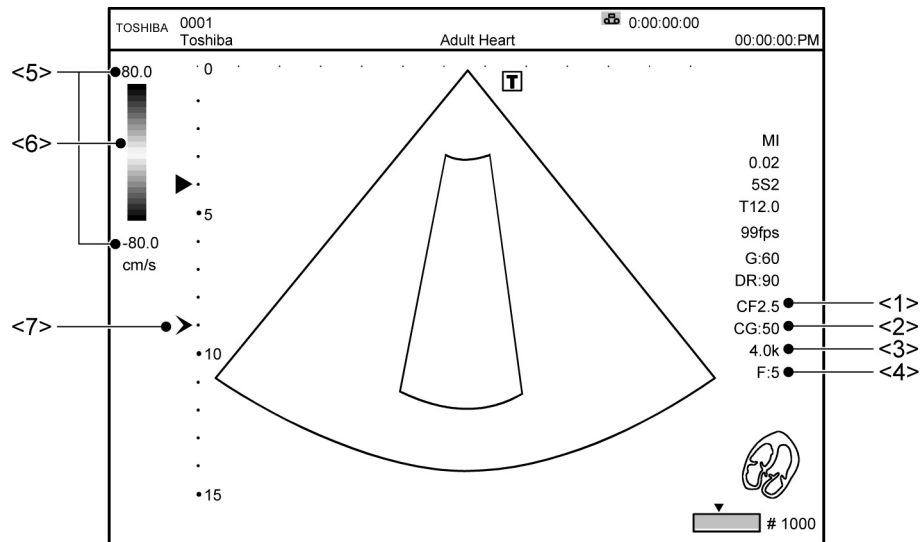

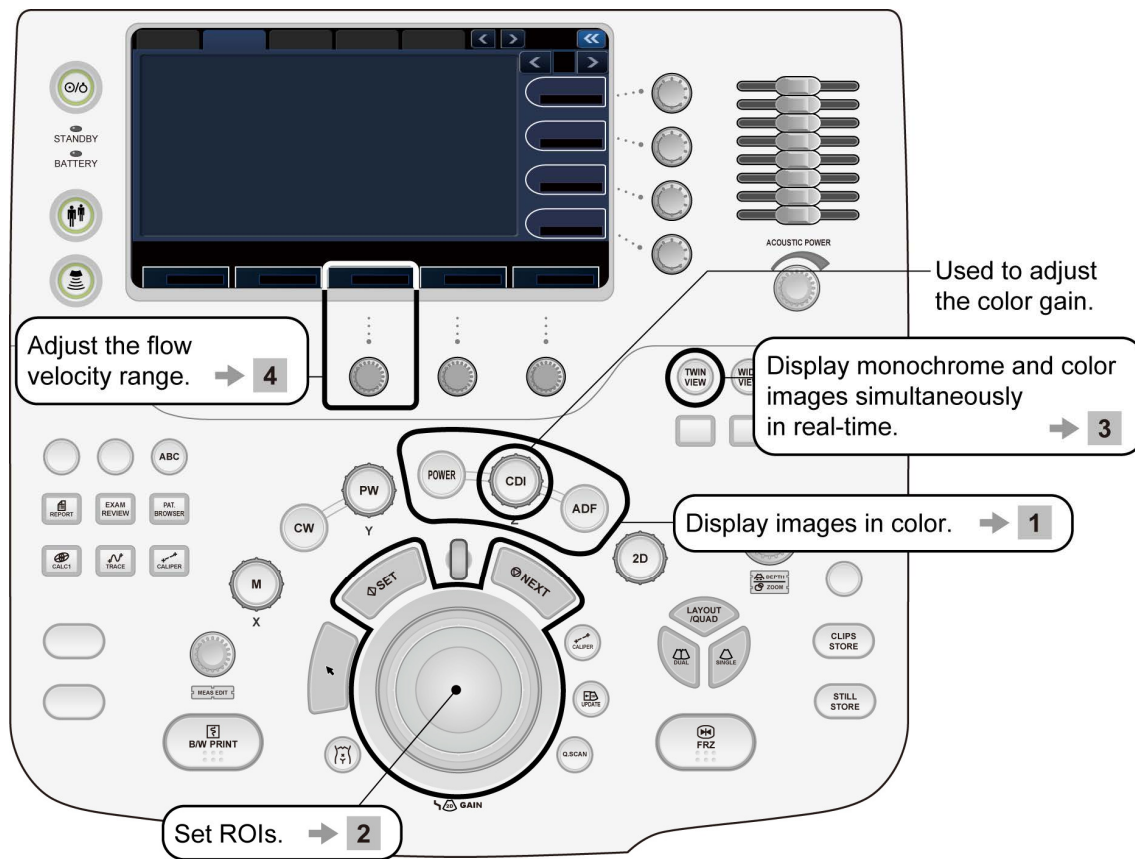

No.	Displayed item
<1>	Color transmission/reception frequency
<2>	Color gain
<3>	Color PRF
<4>	Color filter
<5>	Color flow velocity range
<6>	Color bar
<7>	Color focus mark

### 14.3.2 Adjustment using the main panel





#### 1 Displaying images in color

-  Color mode
-  Power mode
-  Dynamic flow (high-resolution Doppler) mode

## 2 Moving and resizing an ROI

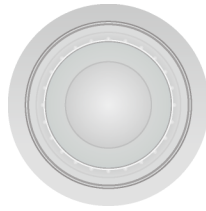
### (1) Moving an ROI



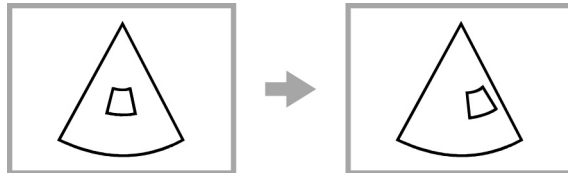

In the Color mode, an ROI can be moved using the trackball (the functional icon must appear ).

The ROI moves according to the movement of the trackball.

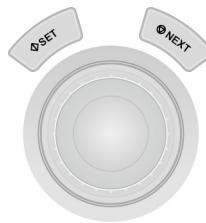

### (2) Resizing an ROI



Use  to change the function icon to .

The ROI can be resized using the trackball.

When resizing is done, press  to set the size.

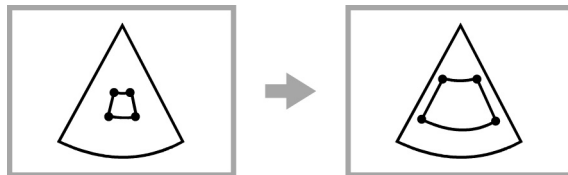

## 3 Displaying real-time monochrome and color images simultaneously



Press this switch to start the mode that displays real-time monochrome and color images simultaneously in dual display mode.

## 4 Adjusting the flow velocity range



To adjust the flow velocity range, use the **[Scale]** knob.

Narrows the range for the display of low-velocity blood flows.  
(Counterclockwise rotation)



Widens the range for the display of high-velocity blood flows.  
(Clockwise rotation)











**NOTE:** Decreasing the scale control may allow more low-velocity signals from moving tissues to be introduced, thereby potentially lowering the Color Doppler velocities displayed on the screen.  
Note that, depending on the flow dynamics and the surrounding tissues, it may be necessary to raise the scale control to optimize the Color Doppler display.

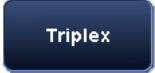

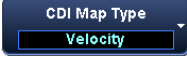

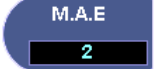



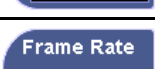



### 14.3.3 Adjustment using the touch panel

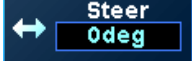

<<Display example>> Exam Type: **[Abdomen]**, Transducer: PVT-375BT

Switch	Function
<b>[Sub Preset]</b>	Displays created sub presets.
 M/D Cursor	Turns the M/D cursor display ON/OFF in single display mode
 TwinView	Displays monochrome and color images simultaneously in real-time.
 Triplex	Used to set simultaneous display of CDI and PW images at the time of switching from CDI mode to PW mode to ON/OFF.
 REVERSE	Used to reverse colors.
 CDI Map Type Velocity	Used to select the color mode display type.
 FIO	Sets the color-display optimization function to ON/OFF.
 Apure+ With Color	Used to automatically turn OFF ApliPure+ processing for the 2D image in the background in color mode.
 M.A.E 2	Used to adjust the degree of reduction of motion artifacts.
 Data No. 1	Used to adjust the sensitivity for low-velocity blood flow.
 Angle Corr 0deg	Used to correct the angle relative to the Doppler beam.
 Gate Size 3.0mm	Used to adjust the PW Doppler range gate size.
 Color Map 5	Used to adjust the hue of the color images.
 Frame Rate 2	Used to adjust the color image quality and the number of frames.

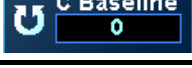
Switch	Function
 Variance 2	Used to adjust the color variance. * Note that this switch is enabled only when the [CDI-Map Type] is [Vel-Variance].
 Filter 3	Used to select the type of low-cut filter.
 Scale	Used to adjust the velocity scale.
 C Freq. CF 2.2	Used to select the transmission/reception frequency.
 Steer 0deg (*)	Used to adjust the angle for oblique scanning in color mode.
 Frm Intrl 0	Used to adjust the frame interpolation.
 Spat. Smth 1	Used to adjust the spatial smoothness of the image.
 Time Smth 3	Used to adjust the motional smoothness of the image.
 Balance 14	Used to adjust the color/monochrome balance.
 C Focus 50%	Used to adjust the color focus position.
 C Baseline 0	Used to move the baseline (0-Hz line) vertically.

(\*) Available when a linear transducer is selected.

## 14.4 Power Angio Mode (Power Mode)

The power value information for the blood flow can be displayed in Power Angio mode.

Press  to display images in Power Angio mode.

### 14.4.1 Power Angio display layout

Refer to subsection 14.3.1 "CDI display layout".











### 14.4.2 Adjustment using the main panel

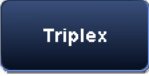





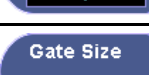

Refer to subsection 14.3.2 "Adjustment using the main panel".

### 14.4.3 Adjustment using the touch panel

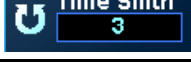

<<Display example>> Exam Type: **[Abdomen]**, Transducer: PVT-375BT

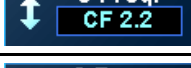
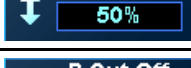
Switch	Function
<b>[Sub Preset]</b>	Displays created sub presets.
 M/D Cursor	Turns the M/D cursor display ON/OFF in single display mode.
 TwinView	Displays monochrome and color images simultaneously in real-time.
 Back Disp	Sets monochrome display to ON/OFF within the ROI.
 Triplex	Used to set simultaneous display of Power and PW images at the time of switching from Power to PW mode to ON/OFF.
 FIO	Sets the color-display optimization function ON/OFF.
 REVERSE	Used to reverse colors.
 Angle Corr 0deg	Used to correct the angle relative to the Doppler beam.
 M.A.E 2	Used to adjust the degree of reduction of motion artifacts.
 Data No. 1	Used to adjust the sensitivity for low-velocity blood flow.
 Gate Size 3.0mm	Used to adjust the PW Doppler range gate size.
 Color Map 5	Used to adjust the hue of the color images.
 Frame Rate 2	Used to adjust color image quality and the number of frames.

Switch	Function
 Power DR 30	Used to adjust the Power dynamic range
 Steer 0deg (*)	Used to adjust the angle for oblique scanning in Power mode.
 Scale	Used to adjust the velocity scale.
 Filter 3	Used to select the type of low-cut filter.
 Frm Intrpl 0	Used to adjust the frame interpolation.
 Time Smth 3	Used to adjust the smoothness of image motion.
 Spat. Smth 1	Used to adjust the spatial smoothness of the image.
 C Freq. CF 2.2	Used to select the transmission/reception frequency.
 C Focus 50%	Used to adjust the color focus position.
 P Cut Off 5	Used to adjust the Power image color.
 Balance 14	Used to adjust the color/monochrome balance.

(\*) Available when a linear transducer is selected.

## 14.5 Dynamic Flow Mode (ADF Mode)

The blood flow information can be displayed at a high resolution in Dynamic Flow mode.

Press  to display images in ADF mode.

The color transmission/reception frequency is displayed as [DF \*.\*].

### 14.5.1 Dynamic Flow display layout

Refer to subsection 14.3.1 "CDI display layout".









### 14.5.2 Adjustment using the main panel







Refer to subsection 14.3.2 "Adjustment using the main panel".

### 14.5.3 Adjustment using the touch panel



<<Display example>> Exam Type: **[Abdomen]**, Transducer: PVT-375BT

Switch	Function
<b>[Sub Preset]</b>	Displays created sub presets.
	Used to set simultaneous display of ADF and PW images at the time of switching from ADF mode to PW mode to ON/OFF.
	Used to reverse colors.
	Turns the M/D cursor display ON/OFF in single display mode.
	Displays monochrome and color images simultaneously in real-time.
	Used to correct the angle relative to the Doppler beam.
	Used to adjust the sensitivity for low-velocity blood flow.
	Used to change the width of the sampling gate.
	Used to adjust the color of the images.
	Used to adjust the color image quality and number of frames.
	Used to adjust the frame interpolation.
	Used to adjust the smoothness of image motion.

Switch	Function
	Used to adjust the spatial smoothness of the image.
	Used to adjust the color focal position.
	Used to adjust the velocity scale.
 (*)	Used to adjust the angle for oblique scanning in ADF mode.
	Used to adjust the low-cut filter.
	Used to select the transmission/reception frequency.

(\*) Available when a linear transducer is selected.



## 14.6 TDI Mode (Tissue Doppler Imaging Mode)

In TDI mode, the Doppler effect is applied to display the kinetic speed of tissues in living organisms.

It can be used to detect abnormal wall motion caused by symptoms such as myocardial infarction.

Perform the following to display the [TDI] screen.

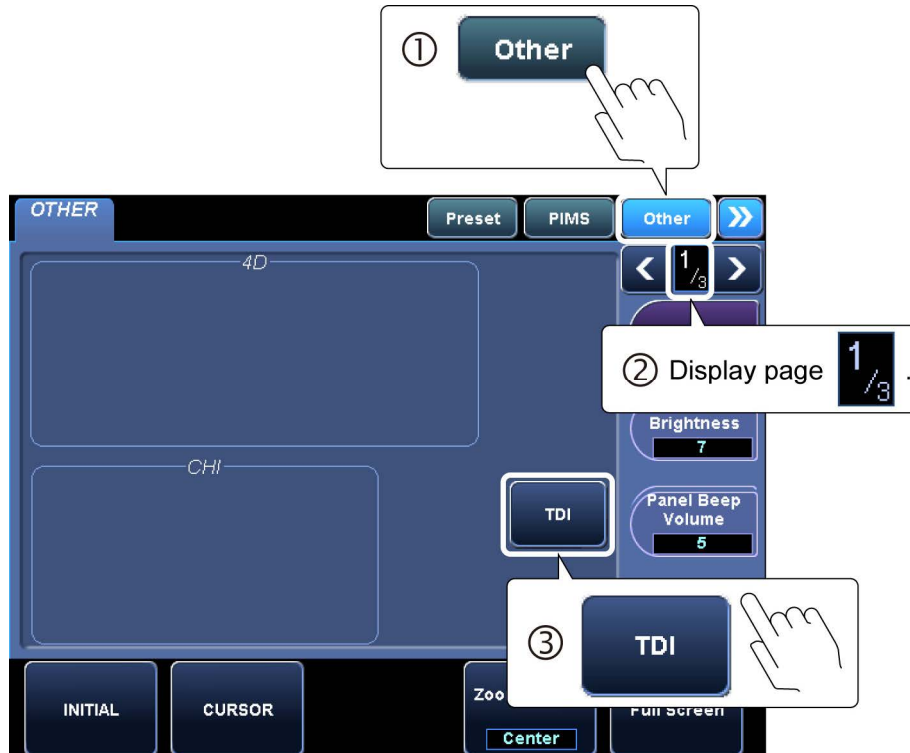

### 14.6.1 TDI display layout

Refer to subsection 14.3.1 "CDI display layout".













### 14.6.2 Adjustment using the main panel

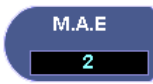

Refer to subsection 14.3.2 "Adjustment using the main panel".

### 14.6.3 Adjustment using the touch panel

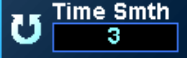

<<Display example>> Exam Type: **[Adult Heart]**, Transducer: PST-30BT

Menu	Function
<b>[Sub Preset]</b>	Displays created sub presets.
 M/D Cursor	Turns the M/D cursor display ON/OFF in single display mode.
 TwinView	Displays monochrome and color images simultaneously in real-time.
 Angle Corr 0deg	Used to correct the angle relative to the Doppler beam.
 Gate Size 3.0mm	Used to change the width of the sampling gate.
 Color Map 5	Used to adjust image colors.
 Data No. 1	Used to adjust sensitivity for low-velocity tissues.
 M.A.E 2	Used to adjust the degree of reduction of motion artifacts.
 Frame Rate 2	Used to adjust the color image quality and the number of frames.
 Scale	Used to adjust velocity scale of tissues.
 C Freq. CF 2.2	Used to select transmission/reception frequency.
 TDI Cut Off 0	Used to adjust the low-speed color display level.
 Frm Intrpl 0	Used to adjust frame interpolation.
 Spat. Smth 1	Used to adjust spatial smoothness of the image.

Menu	Function
	Used to adjust the motional smoothness of the image.
	Used to adjust the color/monochrome balance.
	Used to adjust the color focus position.

## 14.7 Doppler Mode

Press **PW** or **CW** to display the Doppler mode.

### 14.7.1 Doppler display layout

<<Example layout>>

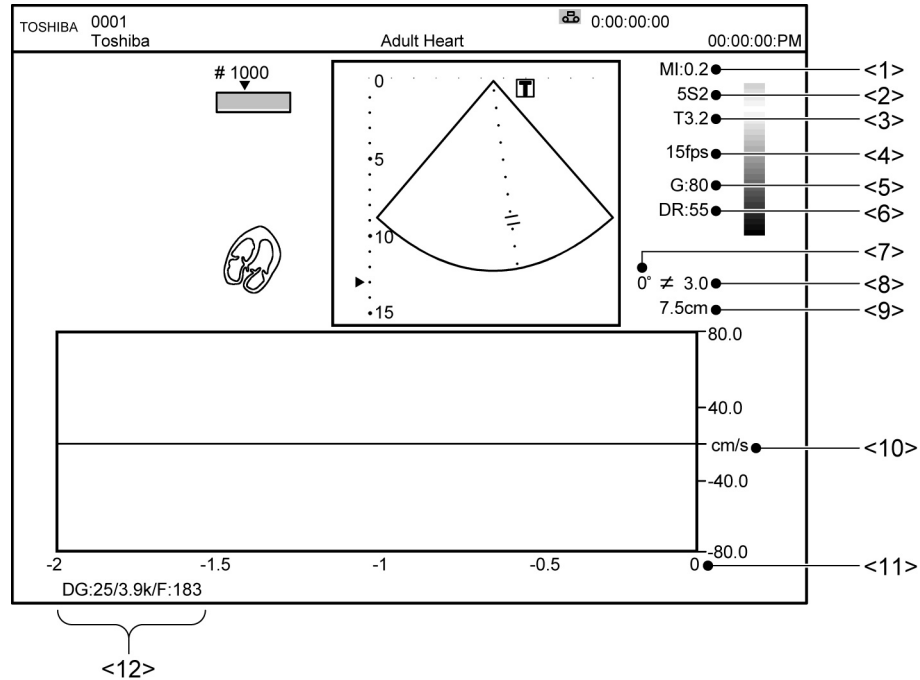

No.	Displayed item
<1>	MI value
<2>	Transducer information
<3>	2D frequency
<4>	Frame rate
<5>	2D gain
<6>	2D dynamic range
<7>	Doppler angle (PW only)
<8>	Doppler gate size
<9>	Doppler gate position
<10>	PW/CW Doppler velocity scale
<11>	Time scale
<12>	PW/CW Doppler gain/PRF/Filter

## 14.7.2 Adjustment using the main panel

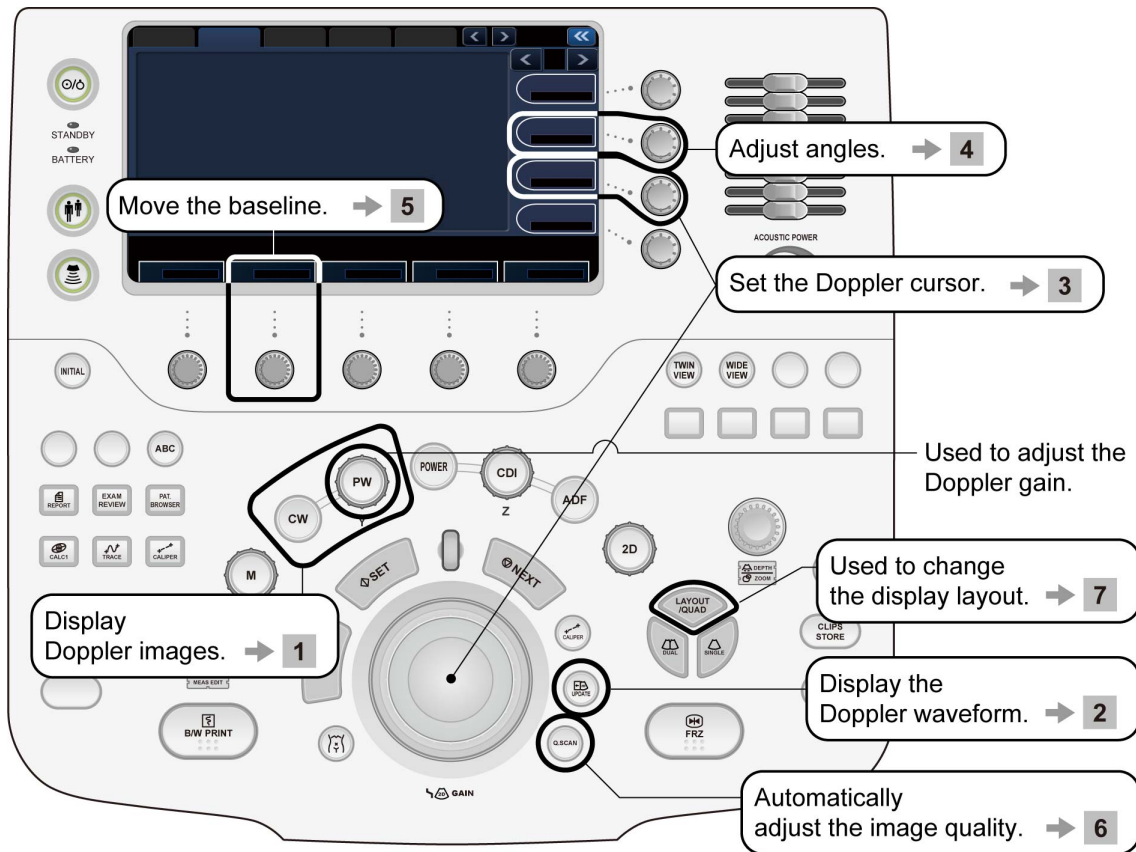

### 1 Displaying the Doppler mode



**[PW]** (pulsed-wave Doppler) screen (2D+PW display)

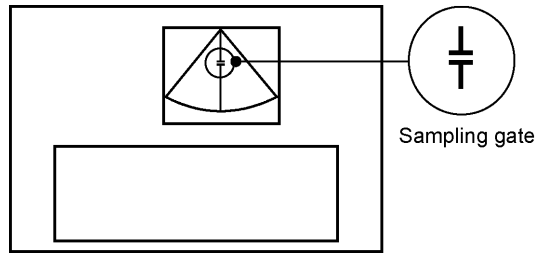

**[CW]** (continuous-wave Doppler) screen (2D+CW display)

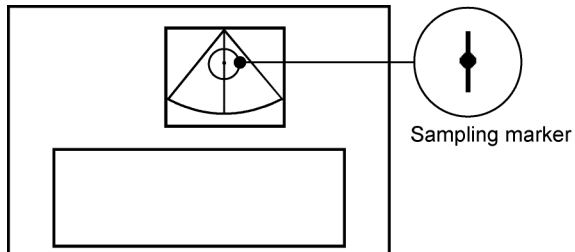

## 2 Displaying the Doppler waveform

---



Each time this switch is pressed, the 2D image is frozen or displayed in real time.

## 3 Setting the Doppler cursor

---

(1) Sampling gate ( $\frac{1}{T}$ : 2D+PW mode)

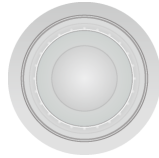

: Position the gate at the target location using the trackball.



: Rotate the corresponding knob to adjust the gate width.

(2) Sampling marker ( $\downarrow$ : 2D+CW mode)

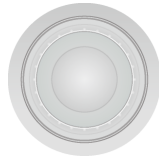

: Position the marker at the target location using the trackball.

## 4 Adjusting the angle

---



Use the [**Angle Corr**] knob to align the angle correction mark with the blood flow direction.

Note that the velocity scale is calculated automatically. In addition, this operation can also be performed in Freeze mode.

## 5 Adjusting the baseline

---

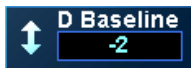

Use the [**D Baseline**] knob to adjust the baseline.

Knob  : Raises the baseline.

Knob  : Lowers the baseline.

This operation can also be performed in Freeze mode.

---

## 6 Automatically adjusting the image quality (Doppler mode quick scan)

---



When this switch is pressed, the following parameters are adjusted automatically.

Note, however, that the automatic update function is not supported for Doppler mode quick scan.

- Doppler velocity range (**[DOP Scale]**)
- Doppler baseline shift (**[D Baseline]**)

## 7 Changing the display layout

---



This switch can be used to cycle through the available display layouts. Each time the switch is pressed, the display layout changes to the next one in a predetermined order.

Pressing  on the touch panel allows the display layout to be selected directly from the pull-down menu.

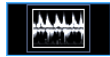

Full (available only when the image is frozen)

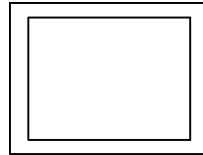

Side by side

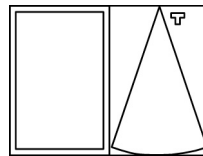

Up/Down 2/3

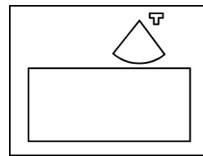

Up/Down 1/2

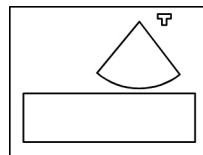

Up/Down 1/3

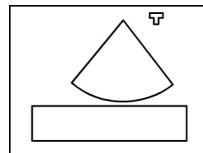

### 14.7.3 Adjustments using the touch panel









(1) [PW] page















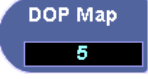

<<Display example>> Exam Type: **[Abdomen]**, Transducer: PVT-375BT

Switch	Function
<b>[Sub Preset]</b>	Displays created sub presets.
<b>DOP Layout</b>	Used to select the image size in 2D+PW display mode. Refer to <b>6</b> of subsection 14.7.2 "Adjustment using the main panel" for details.
<b>REVERSE</b>	Used to reverse the waveform.
<b>Triplex</b>	Used to set simultaneous display of Color and PW images at the time of switching from Color mode to PW mode to ON/OFF.
<b>Auto Trace</b>	Used to select whether or not the trace line is to be displayed in Doppler mode.
<b>Q. Scan Sel</b> NonSync.BD	Used to select which modes Quick scan is enabled for when <b>[Q. Scan]</b> is pressed. <b>[B-Only]</b> : Quick scan is enabled only for 2D mode. <b>[D-Only]</b> : Quick scan is enabled only for Doppler mode. <b>[Sync.BD]</b> : Quick scan is enabled for both 2D mode and Doppler mode when both 2D mode and Doppler mode real-time images are displayed. <b>[NonSync.BD]</b> : Quick scan is enabled only for Doppler mode when both 2D mode and Doppler mode real-time images are displayed.
<b>Q. Scan Obser.Time</b> Middle	Used to specify the length of viewing time used for calculating the velocity range and baseline value for <b>[Q. Scan]</b> . <b>[Short]</b> , <b>[Middle]</b> , or <b>[Long]</b> can be selected.
<b>Q. Scan Disp.Ratio</b> Middle	Used to specify the waveform display size for the velocity range for <b>[Q. Scan]</b> . <b>[Small]</b> , <b>[Middle]</b> , or <b>[Large]</b> can be selected.

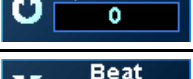
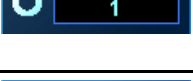
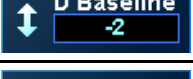

Switch	Function
	Used to select whether the 2D (CDI) mode image is displayed in real time ( <b>[2D REAL]</b> ) or the M-mode or Doppler mode image is displayed in real time ( <b>[MD REAL]</b> ), when Doppler mode is entered from 2D (CDI) mode.
	Used to select whether the Doppler scale is set to velocity ( <b>[cm/s]</b> ) or frequency ( <b>[Hz]</b> ).
	Used to set high-velocity support mode to ON/OFF in 2D+PW display mode.
 (*)	<p>Used to specify whether or not the color mode (CDI/Power/ADF) steering operation and PW steering operation are to be performed independently in oblique scan.</p> <p>ON : Independent operation for CDI steering and PW steering.  OFF : Simultaneous operation for CDI steering and PW steering.</p>
 (*)	Used to invert the Doppler oblique scan angle. When this switch is pressed while the Doppler oblique scan angle is set to an angle other than 0°, the oblique scan angle is inverted.
 (*)	<p>Used to select whether the ±10° PW steering angle setting is skipped when <b>[Indep. Steer]</b> is set to ON. The linear transducer can normally be set to a maximum PW oblique scan angle of ±30° in increments of ±10°.</p> <p>ON : PW steering angle settings 0°, ±20°, ±30°  OFF : PW steering angle settings 0°, ±10°, ±20°, ±30°</p>
 (*)	<p>Used to reverse the velocity direction automatically according to the angle of CDI or Doppler steering.</p> <p>Specify whether or not the steering direction relative to the center (from right to left or from left to right), the color velocity range, the Doppler velocity range, and the Doppler Angle Corr. mark are reversed when steering is performed for the Color ROI or sampling marker using the linear transducer with <b>[Indep. Steer]</b> set to ON.</p> <p>The selection menu is as follows:</p> <p><b>[Off]</b> : Even if the steering direction is reversed, the velocity ranges and the Doppler Angle Corr. mark are not inverted.</p> <p><b>[COL &amp; Angle]</b>: If the steering direction is reversed, the color ROI and the Doppler Angle Corr. mark are inverted.</p> <p><b>[PW &amp; Angle]</b> : If the steering direction is reversed, the sampling marker (PWD) and the Doppler Angle Corr. mark are inverted.</p> <p><b>[ALL]</b> : If the steering direction is reversed, the color ROI, the sampling marker, and the Doppler Angle Corr. mark are inverted.</p> <p><b>[Angle only]</b> : If the steering direction is reversed, the Doppler Angle Corr. mark is inverted.</p>
	<p>Used to select the display type for Doppler auto trace line.</p> <p><b>[PEAK]</b> : Only the peak velocity trace is displayed.  <b>[MEAN]</b> : Both the peak velocity trace and the mean velocity trace are displayed.</p>

Switch	Function
	Used to adjust the threshold for Doppler tracing. The tracing result varies depending on the threshold setting.
	Used to adjust the temporal smoothness of the Doppler auto trace line with respect to the waveform. The tracing result varies depending on the setting.
	Used to select the trace range for Doppler auto trace. <b>[FOR]</b> : The Doppler waveform above the baseline is traced. <b>[REV]</b> : The Doppler waveform below the baseline is traced. <b>[FULL]</b> : The entire Doppler waveform is traced. <b>[AUTO]</b> : <ul style="list-style-type: none"> <li>• When the baseline is at or below the center, the waveform above the baseline is traced.</li> <li>• When the baseline is above the center, the waveform below the baseline is traced.</li> </ul>
	Used to adjust the PW Doppler range gate size.
	Used to adjust the Doppler sound volume. ON : Turning the dial adjusts the balance. OFF : Turning the dial adjusts the sound volume.
	Used to correct the angle relative to the Doppler beam.
	Used to adjust the image color.
	Used to adjust the sweep speed of the Doppler image.
	Used to adjust the gamma curve.
	Used to adjust the dynamic range.
	Used to adjust the pixel ratio of the image.
	Used to adjust the 2D mode image quality or PW mode image quality in 2D+PW display mode.
	Used to specify the number of heartbeat waveforms used for performing automatic measurement for the Doppler auto trace line.
	Used to move the baseline (0-Hz line) vertically.
	Used to adjust the Doppler velocity scale.

Switch	Function
	Used to reduce low-velocity noise.
	Used to select the transmission/reception frequency.
 (*)	Used to adjust the angle for oblique scan in Doppler mode.











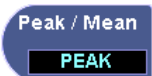

(\*) Available when a linear transducer is selected.

(2) [CW] Page

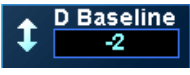

<<Display example>> Exam Type: [Adult Heart], Transducer: PST-30BT

Switch	Function
[Sub Preset]	Displays created sub presets.
	Used to select the image size in 2D+CW display mode. Refer to <b>6</b> of subsection 14.7.2 "Adjustment using the main panel" for details.
	Used to reverse the waveform.
	Switches between showing and hiding the Doppler trace line.
	Used to select which modes Quick scan is enabled for when [Q. Scan] is pressed. <b>[B-Only]</b> : Quick scan is enabled only for 2D mode. <b>[D-Only]</b> : Quick scan is enabled only for Doppler mode. <b>[Sync.BD]</b> : Quick scan is enabled for both 2D mode and Doppler mode when both 2D mode and Doppler mode real-time images are displayed. <b>[NonSync.BD]</b> : Quick scan is enabled only for Doppler mode when both 2D mode and Doppler mode real-time images are displayed.
	Used to specify the length of viewing time used for calculating the velocity range and baseline value for [Q. Scan]. <b>[Short]</b> , <b>[Middle]</b> , or <b>[Long]</b> can be selected.
	Used to specify the waveform display size for the velocity range for [Q. Scan]. <b>[Small]</b> , <b>[Middle]</b> , or <b>[Large]</b> can be selected.
	Used to select whether the 2D mode image is displayed in real time ( <b>[2D REAL]</b> ) or the M-mode or Doppler mode image is displayed in real time ( <b>[MD REAL]</b> ), when Doppler mode is entered from 2D mode.
	Used to select whether the Doppler scale is set to velocity ( <b>[cm/s]</b> ) or frequency ( <b>[Hz]</b> ).

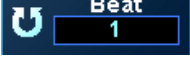
Switch	Function
	Used to adjust the Doppler sound volume.
	Used to correct the angle relative to the Doppler beam.
	Used to select the trace range for Doppler auto trace. <b>[FOR]</b> : The Doppler waveform above the baseline is traced. <b>[REV]</b> : The Doppler waveform below the baseline is traced. <b>[ALL]</b> : The entire Doppler waveform is traced.
	Used to select the display type for Doppler auto trace line. <b>[PEAK]</b> : Only the peak velocity trace is displayed. <b>[MEAN]</b> : Both the peak velocity trace and the mean velocity trace are displayed.
	Used to adjust the threshold for Doppler tracing. The tracing result varies depending on the threshold setting.
	Used to adjust the temporal smoothness of the Doppler auto trace line with respect to the waveform. The tracing result varies depending on the setting.
	Used to adjust the image color.
	Used to adjust the sweep speed of the Doppler image.
	Used to move the baseline (0-Hz line) vertically.
	Used to adjust the Doppler velocity scale.
	Used to reduce low-velocity noise.
	Used to select the transmission/reception frequency.
	Used to adjust the gamma curve.
	Used to adjust the dynamic range.
	Used to adjust the pixel ratio of the image.
	Used to specify the number of heartbeat waveforms used for performing automatic measurement for the Doppler auto trace line.

# 15. Cine Function

## 15.1 Overview

When an image is frozen, the images immediately before the frozen image can be played back and edited. This function is called Cine. Cine images are cleared by turning OFF the power or unfreezing the frozen image.

## 15.2 Cine Operations

Press  to freeze the image. The  icon is displayed in the trackball function area.

### 1 Frame-by-frame playback mode

---

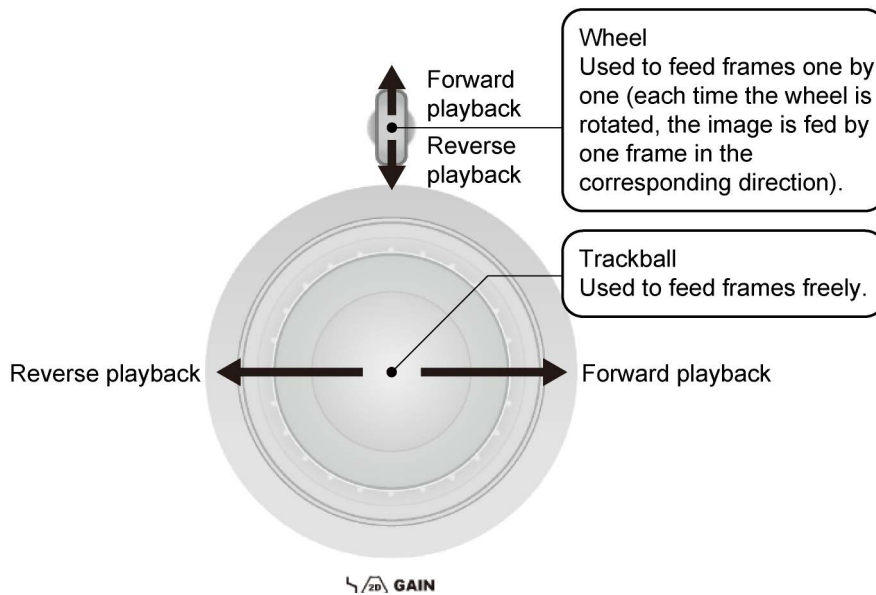

\* For M mode or Doppler mode images, scroll playback is performed instead of frame-by-frame playback.

---

## 2 Continuous playback (loop) mode

### Palm dial

When the dial is rotated during frame-by-frame playback mode, continuous playback (loop) mode is set. The playback speed can be adjusted using the same palm dial.

Reducing the playback speed  
(counterclockwise rotation)

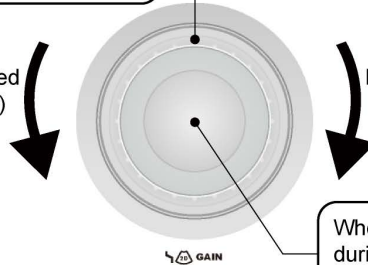

Increasing the playback speed  
(clockwise rotation)

When the trackball is operated during continuous playback mode, frame-by-frame mode is set again.

## 3 Setting the loop range for frame-by-frame playback

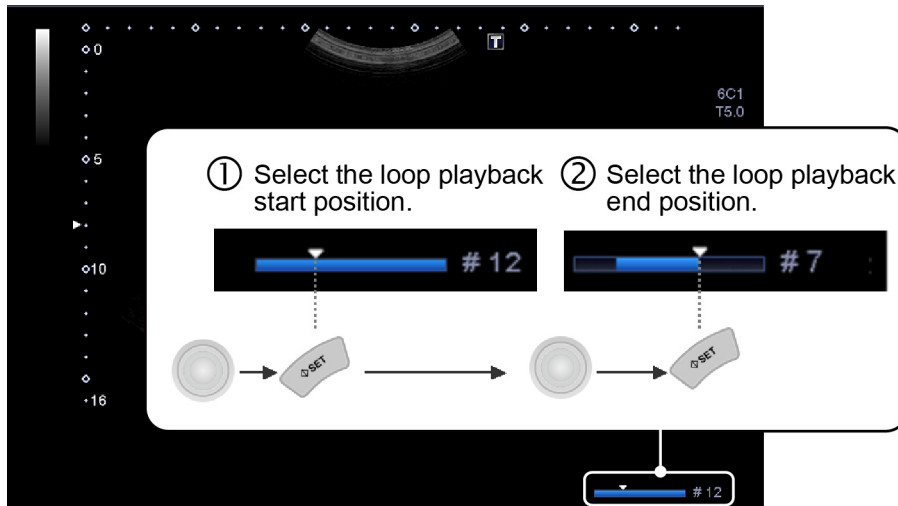

**NOTE:** 1. When both images are frozen in 2D dual display mode, cine processing is applied to the image for which the cine icon and the character "T" indicating the scanning direction are brighter. To change the target, press



2. Auto data displayed on an image played back from the cine memory  
The auto data displayed on an image played back from the cine memory reflects the values at the time at which the image was frozen. Note this when you save an image.
3. Images in the cine memory may be lost due to setting changes. The necessary data should be recorded on storage media such as an HDD using the Clips function or other means as required.
4. Up to 2700 image frames can be played back from the cine memory. When more than 2700 image frames are in the cine memory, the 2700 frames preceding the time the image is frozen are played back.

# 16. Body Mark



A body mark indicating the current examination region can be displayed.

**NOTE:** It is possible to preset the following items for each application preset.

For details, refer to section 11 "Setting the Presets" in the operation manual Measurements volume.

1. Whether or not the body mark is copied from the previous mode when dual display mode is entered.
2. Whether or not the body mark is deleted at the time of unfreezing.

## 16.1 Body Mark Entry Mode

Press  to enter Body mark entry mode. The body mark menu is displayed on the touch panel. To exit from Body mark entry mode, press  again.

<<Display example>>

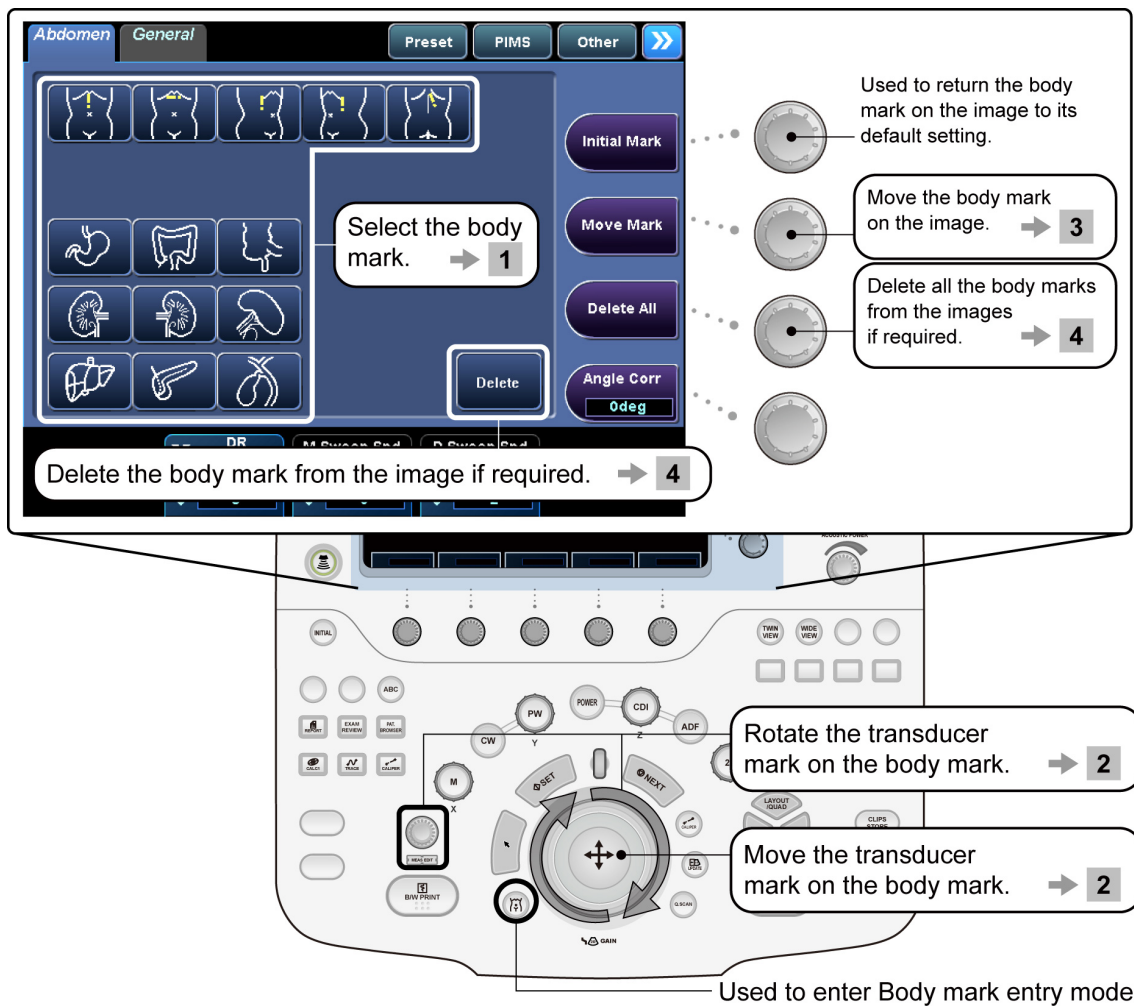



## 16.2 Setting and Editing Body Marks

### 1 Setting body marks



\* To switch to a body mark menu for another application preset, switch to the desired application preset. For details, refer to section 13 "Common Operation for Each Mode".

\* If the menu has two or more tabs, press the tab for the desired page.

### 2 Moving and rotating the transducer mark on the body mark

(1) Moving the transducer mark

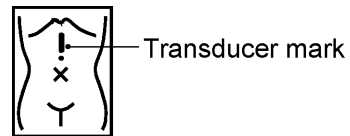

(2) Rotating the transducer mark



The palm dial around the trackball can be used while the image is frozen.

\* The transducer mark is not displayed, depending on Exam Type.

### 3 Moving the body mark

(1) Press the knob next to  .

(2) Operate  to move the body mark.

(3) Press the knob next to  again to set the position of the body mark.

#### 4 Deleting the body mark

---

Press  .

<<In dual display>>

- To delete the body mark only in the active frame (indicated by  )

Press  .

- To delete the body mark in both frames

Press the knob next to  .

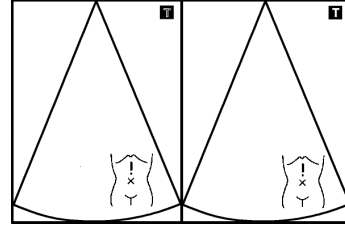

Dual image display



# 17. Entering Comments



To enter comments, enter characters from the keyboard or display characters that have already been registered.

**NOTE:** It is possible to preset the following items for each application preset. For details, refer to section 11 "Setting the Presets" in the operation manual Measurements volume.

1. Whether the comments are deleted or returned to the initial position at the time of mode switching
2. Whether or not the comments are deleted at the time of unfreezing
3. Shape of the cursor in annotation input mode (I cursor or arrow cursor)

## 17.1 Entering Comment Entry Mode

Press  or . The cursor is displayed on the screen and the annotation menu is displayed on the touch panel.

Press  or  a second time to exit Comment entry mode.

\* To change the diagnostic area in the annotation menu, switch the application preset (refer to section 13 "Common Operation for Each Mode").

## 17.2 Entering/Editing Characters and Arrow Marks

<<Display example>>

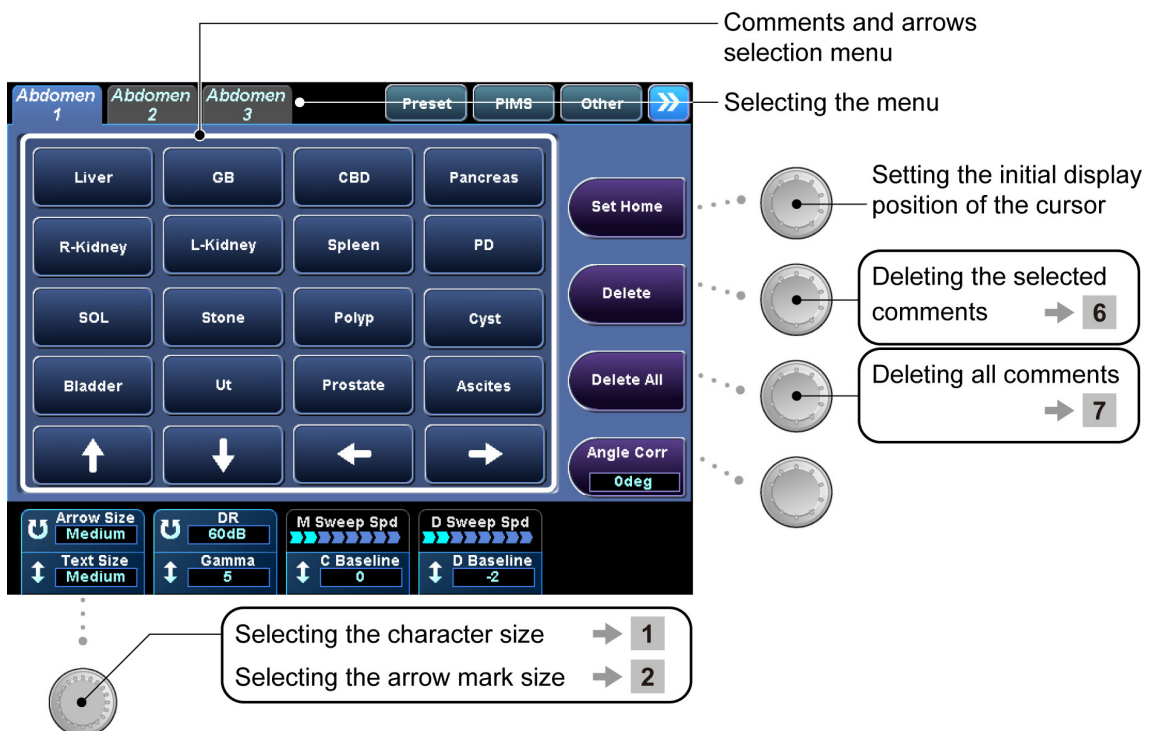

# 1 Character entry

- (1) Entering a comment by selecting an item from the menu registered in the touch panel.

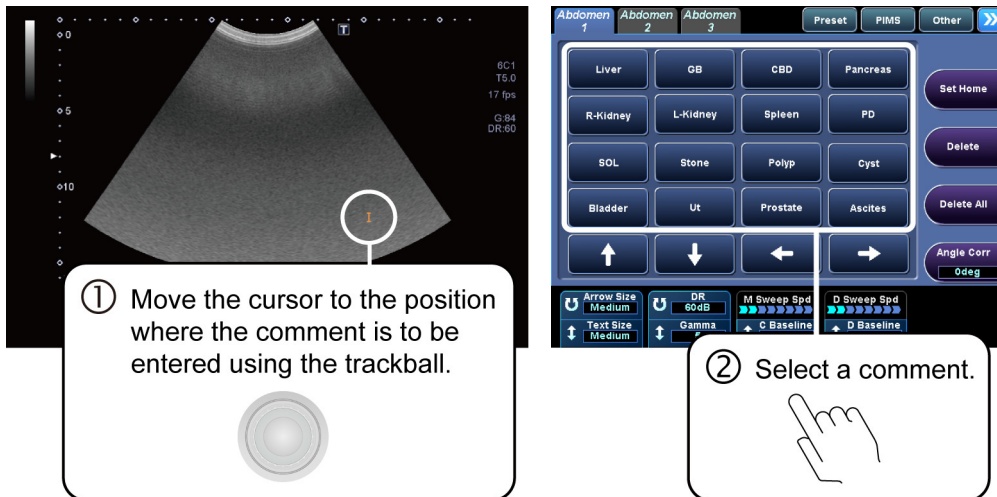

- (2) Entering a comment directly from the keyboard.

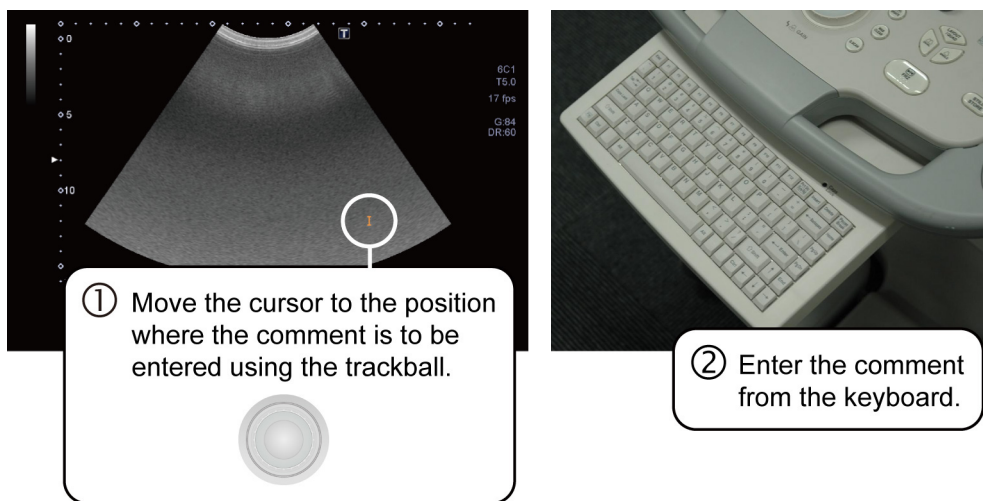

\* The character size can be adjusted using the knob of the



## 2 Entering arrow marks

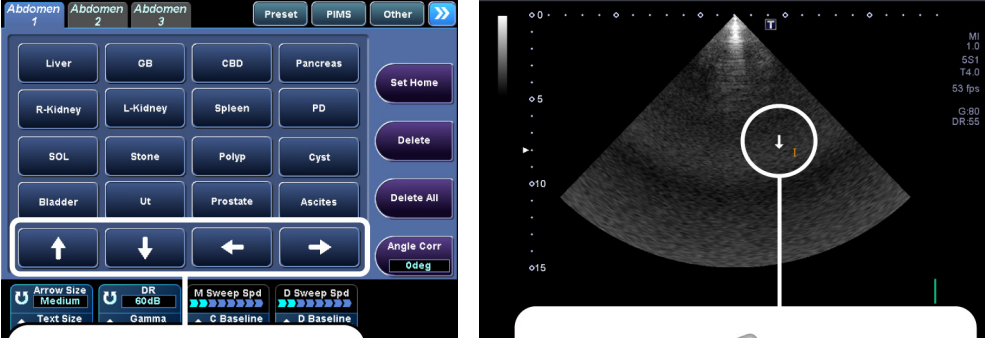

① Select an arrow button.

② Press  to set the mark (the arrow turns white).



: Changes the size of the arrow.





: Rotates the arrow.

\* The palm dial around the trackball can be used while the image is frozen.

## 3 Correcting comments

- (1) Use the trackball to move the cursor to the comment to be corrected.
- (2) Enter the characters from the keyboard.
  - \* Pressing the  key on the keyboard toggles between insert mode and overwrite mode.
- (3) When the cursor is moved, the changes are set and the new comment is displayed in white.

## 4 Moving a selected comment



- (1) Place the cursor on the displayed comment. (The comment turns yellow.)
- (2) Press . (The comment is enclosed in a frame.)
- (3) Move the comment using .
- (4) Press  to set the position.
 

Move the cursor slightly. The comment turns white and is set.

**5** Moving a selected arrow

---

(1) Place the cursor on the displayed arrow. (The arrow turns yellow.)

(2) Hold down  and move the arrow using .



(3) The position is set when  is released.

Move the cursor slightly. The comment turns white and is set.

**6** Deleting a comment or arrow





---

(1) Use  to move the cursor onto the text or arrow to be deleted.  
(The text or arrow turns yellow.)

(2) Press  , or press  on the keyboard.

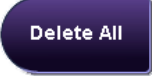
**7** Deleting all comments or all arrows

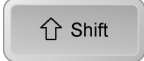
---

Press  , or press  and  on the keyboard at the same time.

---

# 18. Needle Mark

In this system, it is possible to display the needle mark for the specified biopsy adapter on the screen.

Contact your TOSHIBA service representative for details of the needle mark display ON/OFF switch.

When performing a biopsy procedure, be extremely careful to avoid tissue damage, neurological injury, or infection.

The clinical procedures should be selected based on specialized medical judgment.

- ⚠ WARNING:**
- 1. Ultrasound-guided biopsy procedures require a thorough understanding of ultrasound diagnosis and specialized training in biopsy procedures. If biopsy procedures are performed without sufficient knowledge or training, they may be performed incorrectly and the patient may be injured.**
  - 2. In the situations listed below, the biopsy needle may fail to reach the target lesion. Incorrect biopsy may harm the patient.**
    - (a) A defective biopsy adapter is used.**
    - (b) A biopsy adapter other than that specified is used.**
    - (c) The biopsy adapter is mounted incorrectly.**
    - (d) A biopsy needle that is unsuitable for biopsy is used.**
    - (e) A biopsy needle that does not match the biopsy adapter is used.**
    - (f) The operator continues the biopsy procedure when the image is frozen.**
    - (g) The operator does not correctly observe the location of the needle tip.**
    - (h) The selected needle mark angle does not match the angle indicated on the biopsy adapter to be used.**
  - 3. Keeping the following points in mind, carefully monitor the target region and the needle tip while performing a biopsy procedure.**
    - (a) During a biopsy procedure, the needle may deviate from the desired course due to the tissue characteristics or the type of needle. In particular, needles with small diameters may deviate to a greater degree.**
    - (b) The biopsy target may shift due to unexpected patient motion when the biopsy needle is inserted or due to respiratory movement.**
    - (c) The needle mark displayed on the ultrasound image indicates the predicted course of the biopsy needle, not the actual position of the biopsy needle. It should be used only for reference.**

- ⚠ WARNING:**
4. Sterilize the transducer and the biopsy adapter before and after performing a biopsy procedure. Failure to do so may result in the transducer or adapter becoming source of infection.
  5. Even though the biopsy target and the biopsy needle are identified on the image, a biopsy procedure may not always be successful due to dispersion of the ultrasound beam (especially for a tubule or a very small structure). To avoid failure of the biopsy procedure, observe the following precautions.
    - (a) Do not rely solely on the echo of the needle tip on the image. Pay careful attention to the target, which should shift slightly when the biopsy needle comes into contact with it.
    - (b) Perform biopsy only after confirming the size of the target and assessing the likelihood of success of the procedure.



## 18.1 Applicable Transducers and Biopsy Adapters

The needle mark for the specified biopsy adapter can be displayed when the following transducer is connected to the system.

Transducer	Applicable biopsy adapter		Displayed on the screen	
			Biopsy adapter name	Needle mark angle
PVT-375BT	Product name: TOSIHBA TG-1 Bracket* <sup>1</sup> Product No.: 680-085	Product name: Ultra-ProII™ Replacement Kit* <sup>2</sup> Product No.: 610-608	TG-1	52°, 64°
	Product name : Reusable Starter Kits* <sup>3</sup> Product No. : 680-105			
PST-25BT PST-30BT	Product name: TOSIHBA TG-2 Bracket* <sup>1</sup> Product No.: 680-086	Product name: Ultra-ProII™ Replacement Kit* <sup>2</sup> Product No.: 610-608	TG-2	53°, 65°
	Product name : Reusable Starter Kits* <sup>3</sup> Product No. : 680-106			
PLT-604AT PLT-704AT PLT-704SBT	Product name: TOSIHBA TG-3 Bracket* <sup>1</sup> Product No.: 680-087	Product name: Ultra-ProII™ Replacement Kit* <sup>2</sup> Product No.: 610-608	TG-3	39°, 51°
	Product name : Reusable Starter Kits* <sup>3</sup> Product No. : 680-107			
PLT-1204BT PLT-1204BX	Product name: TOSIHBA TG-4 Bracket* <sup>1</sup> Product No.: 680-088	Product name: Ultra-ProII™ Replacement Kit* <sup>2</sup> Product No.: 610-608	TG-4	37°
	Product name : Reusable Starter Kits* <sup>3</sup> Product No. : 680-102			
PLT-805AT PLT-1005BT	Product name: TOSIHBA TG-6 Bracket* <sup>1</sup> Product No.: 680-090	Product name: Ultra-ProII™ Replacement Kit* <sup>2</sup> Product No.: 610-608	TG-6	34°, 51°
	Product name : Reusable Starter Kits* <sup>3</sup> Product No. : 680-109			
PLT-308P	UAGL004A* <sup>4</sup>		UAGL004A	70°, 80°, 90°, 100°
PLT-705BTF PLT-705BTH	UAGV020A		UAGV020A	The needle mark is not displayed for these transducers.
PLT-1204MV	UAGL-015A		UAGL-015A	37°
PVT-350BTP	UAGV-030A* <sup>4</sup>		UAGV-030A	55°, 70°, 85°, 100°
PVT-375MV	UAGV-033A		UAGV-033A	58°, 69°

Transducer	Applicable biopsy adapter		Displayed on the screen	
			Biopsy adapter name	Needle mark angle
PVT-382BT	UAGV-027A		UAGV-027A	67°, 80°
	Product name: BX2™ Biopsy Bracket*5 Product No.: 680-110	Product name: BX2™ Needle Guide*6 Product No.: 680-112		
	Product name : Biopsy Starter Kit*3 Product No. : 680-111			
PVT-382MV	UAGV-032A		UAGV-032A	64°, 78°
PVT-674BT	UAGV-028A		UAGV-028A	47°, 70°
PVT-661VT	UAGV-024A		UAGV-024A	90°
PVT-681MV	UAGV-031A		UAGV-031A	87°
	Product name : CIVCO Needle guide*7 Product No. : 680-114			
PVT-745BTH*10	UAGV-034A		UAGV-034A	60°, -60°
PVT-745BTV	UAGV-029A		UAGV-029A	44°, 75°
PVT-770RT	UAGV-023A		UAGV-023A	93°
	Product name: Reusable Bracket*8 Product No.: 680-093	Replacement Kit*9 Product No.: 680-092	680-093	91°
PVT-781VT	UAGV-035A		UAGV-035A	91°

\*1, \*2, \*3, \*5, \*6, \*7, \*8, \*9 : Manufactured by CIVCO Medical Solutions  
The following must be used in combination: \*1 and \*2, \*5 and \*6, \*8 and \*9.  
The kits marked \*3 include the bracket and the sterile procedure kit.

\*4 : Biopsy adapter supplied with the transducer

\*10 : Selection of the needle mark display angle differs depending on the position in which the biopsy adapter is mounted to the transducer. Refer to **5** of subsection 18.2.1 "Needle mark display" for details.

## 18.2 Needle Mark Display and Angle Change Procedures

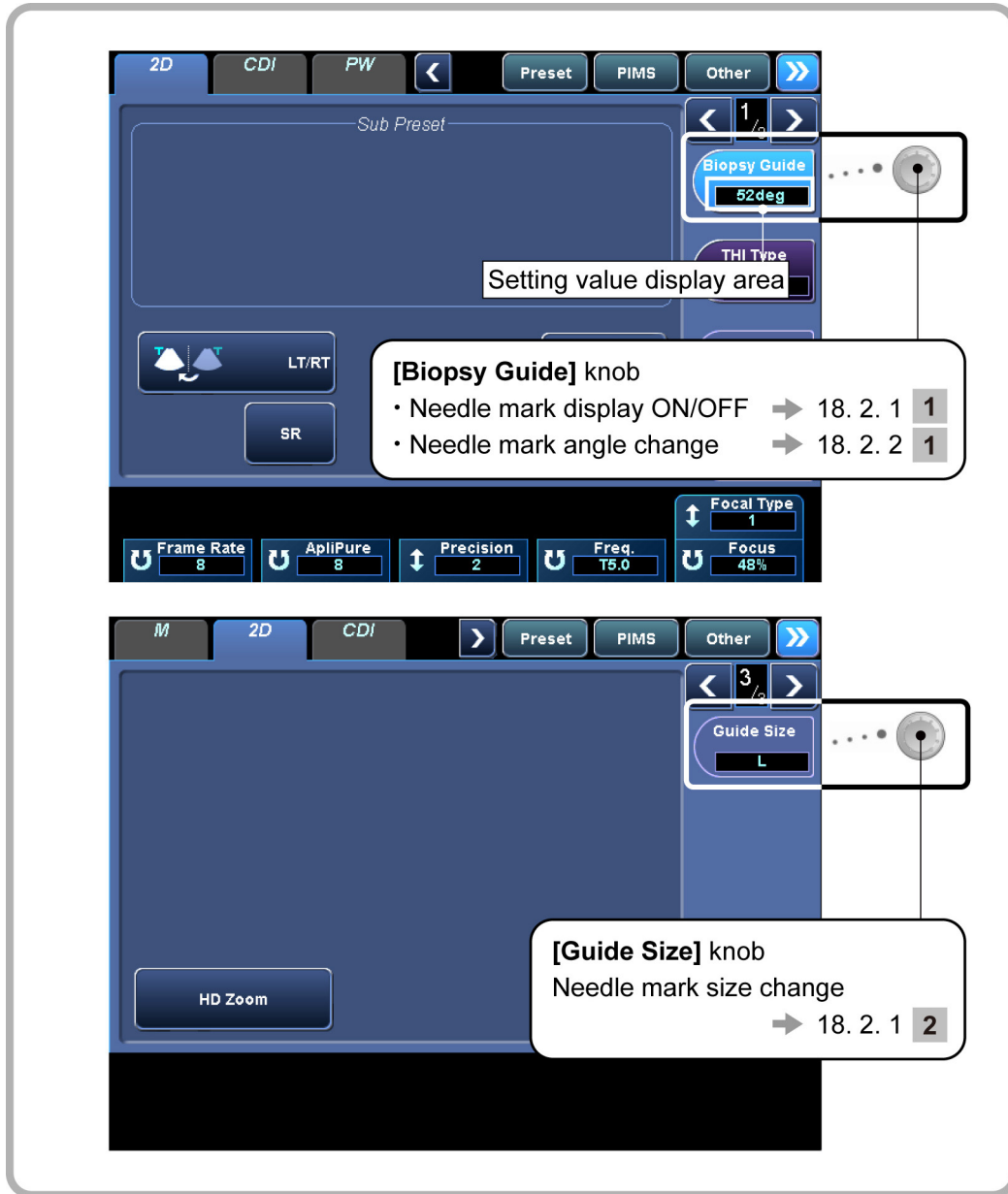

## 18.2.1 Needle mark display

### 1 Turning needle mark display ON/OFF



Pressing the **[Biopsy Guide]** knob displays the needle mark, biopsy adapter name, and needle mark angle on the image. Pressing the same knob again clears the display.

<<Display example>>

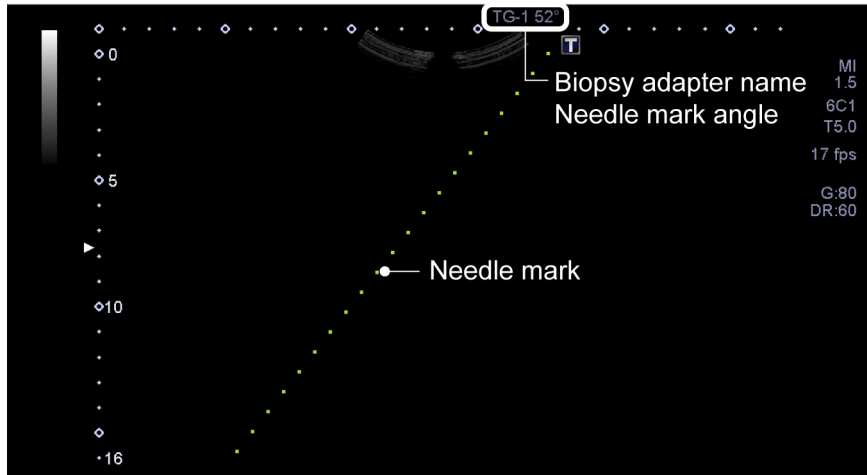

**NOTE:** The Biopsy Guide can be displayed only when the scan range is 100%. Confirm that the scan range is 100% before pressing the **[Biopsy Guide]** knob.

### 2 Changing the needle mark size

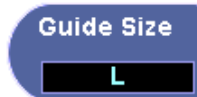

The thickness of the needle mark can be selected using the knob next to this switch.

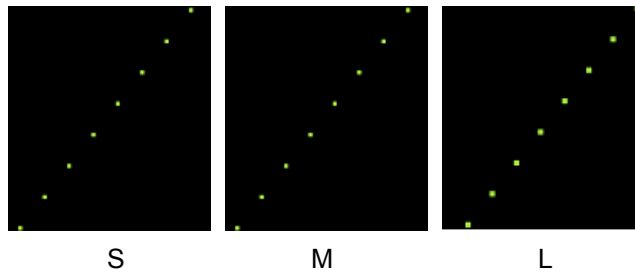

**3** Needle mark display for the PVT-681MV

---

The PVT-681MV supports two types of biopsy adapters, but the same needle mark is displayed for both of them.

In addition, the biopsy adapter name that is displayed at the top of the screen when the needle mark is displayed is **[UAGV-031A]** regardless of which biopsy adapter is used.

**4** Needle mark display for the PVT-382BT

---

The PVT-382BT supports two types of biopsy adapters, but the same needle mark is displayed for both of them.

In addition, the biopsy adapter name that is displayed at the top of the screen when the needle mark is displayed is **[UAGV-027A]** regardless of which biopsy adapter is used.

**5** Needle mark display for the PVT-745BTH

---

The biopsy adaptor (UAGV-034A) can be mounted on the right (the side indicated by the ◁ mark) or left of the PVT-745BTH. The display of the needle mark differs depending on the biopsy adaptor mounting position.

- ① When the biopsy adaptor is mounted on the right of the transducer (the side indicated by the ◁ mark)



Biopsy adaptor  
(the needle guide is on the right side)

UAGV-034A 60°

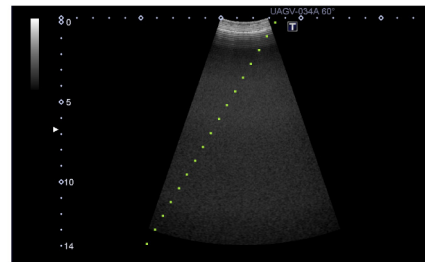

Biopsy Guide  
60deg

- ② When the biopsy adaptor is mounted on the left of the transducer

Biopsy adaptor  
(the needle guide is on the left side)



UAGV-034A -60°

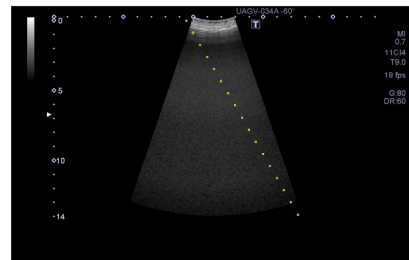

Biopsy Guide  
-60deg

## 18.2.2 Needle mark angle change procedures

### 1 Changing the needle guide angle

---



Rotate the **[Biopsy Guide]** knob while the needle mark is displayed.

For a transducer with two types of display angles, rotating the knob displays the angles that can be selected in the setting value display area.

---

- \* The **[Biopsy Guide]** knob is disabled while the image is frozen.
- \* If a transducer other than one supporting biopsy procedures is connected, **[Biopsy Guide]** is not displayed.

# 19. Storing Image Data



## 19.1 Storing Still Images

Press  to store still images displayed in the image display area.

### 19.1.1 Operations using the touch panel

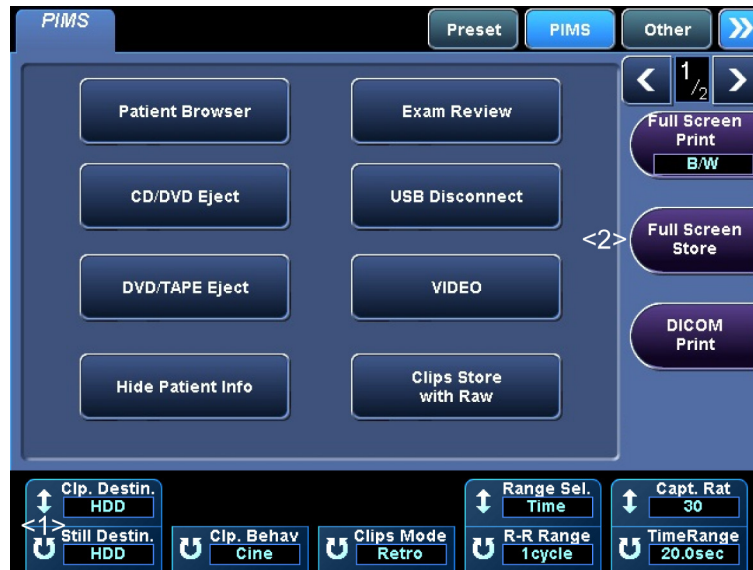
The figure below shows the touch panel menu used for storing still images.



No.	Switch	Function
<1>		The storage destination can be selected. <b>[HDD]</b> : Hard disk <b>[OPTICAL]</b> : CD/DVD* (DICOM cache) <b>[USB]</b> : USB flash drive* <b>[Server]</b> : DICOM server*
<2>		The entire screen (not only the image display area) is stored.

\* When optical media or a server is selected as the destination, the same images are also stored in the HDD.

- NOTE:**
-  is displayed at the bottom of the screen while still images are being stored in the HDD.
  - If the system fails while still images are being stored, the following error message is displayed. When this message is displayed, the images have not been stored. Perform the image storage procedure again.

**[Failed in storing data. Please try again.]**

## 19.2 Storing a Dynamic Image

Press  to store a dynamic image.

There are two methods for storing a dynamic image: Snapshot Clips and Cine Clips.



## 19.2.1 Operations using the touch panel

The figure below shows the touch panel menu used for storing a dynamic image.



No.	Switch	Function
<1>		The storage destination can be selected. <b>[HDD]</b> : Hard disk <b>[OPTICAL]</b> : CD/DVD* (DICOM cache) <b>[USB]</b> : USB flash drive* <b>[Server]</b> : DICOM server*
<2>		This knob is used to specify the number of preceding cardiac cycles for an image that is stored when <b>[CLIPS STORE]</b> is pressed.
<3>		The method for specifying the image storing range can be toggled between R-R (number of cardiac cycles) and Time (seconds).
<4>		This knob is used to specify the number of preceding seconds for an image that is stored when <b>[CLIPS STORE]</b> is pressed.
<5>		The image acquisition frame rate can be selected. Frame rates of 60 Hz, 30 Hz, and 15 Hz can be selected.
<6>		The specified dynamic image is stored together with the raw data. Dynamic images with raw data are used for analysis by the optional TCA and Wall Motion Tracking functions.
<7>		The Snapshot Clips mode can be set to <b>[Retro]</b> or <b>[Pro]</b> .
<8>		The image storage type can be set as <b>[Snapshot]</b> or <b>[Cine]</b> .

\* When optical media or a server is selected as the destination, the same images are also stored in the HDD.

## 19.2.2 Snapshot Clips

There are two modes for Snapshot Clips, Retrospective and Prospective.

The mode can be selected using **[Clips Mode]** on page 2/2 of the **[PIMS]** menu.

### 1 Retrospective storage: Maximum image storage period: 70 seconds

---

#### ① During realtime display

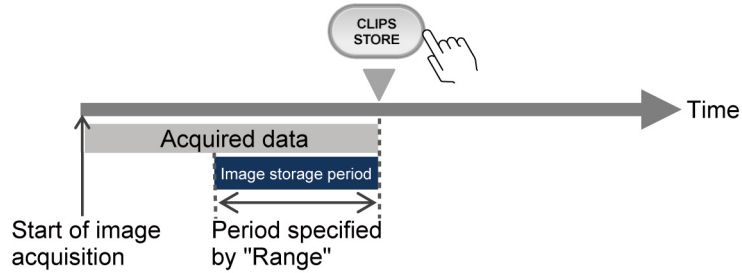

#### ② During freeze

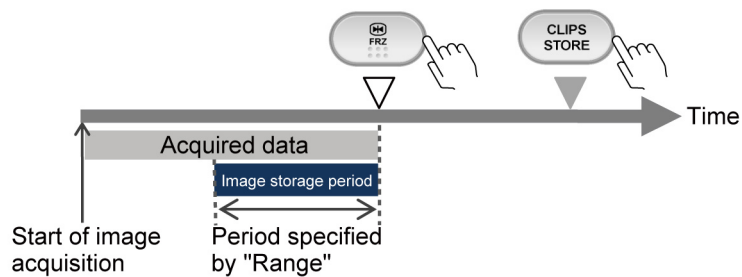

**2** Prospective storage: Maximum image storage period: 180 seconds

---

①

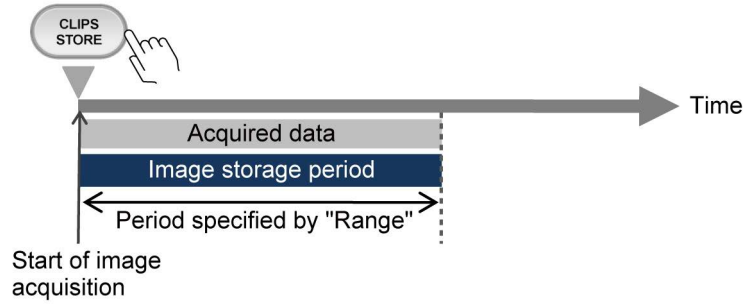

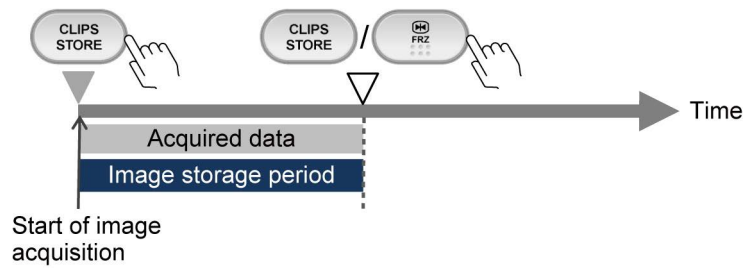

②



**NOTE:** The data for the period shown below is stored, even when the depth, Color ROI position, or other condition is changed during image acquisition.

\* Data for the period specified by "Range"

\* Period from the start of image acquisition to the timing when  is pressed for the second time or when  is pressed.

### 19.2.3 Cine Clips (storage of cine image data)

The image data recorded in the cine memory can be stored.

To use Cine Clips, set **[Clips Store Behavior]** on page 2/2 of the **[PIMS]** menu to **[Cine]**.

- 1 Storing image data for which gain, depth, and/or other image quality conditions have been adjusted after freezing

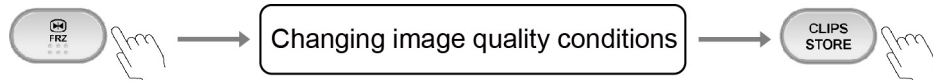

- \* After editing, the cine image data is automatically played back in a loop and stored.
- \* If the image quality conditions for the cine image data have not been adjusted, the image is stored by Snapshot Clips.

- 2 Storing image data for the specified cine loop range (Retrospective mode only)

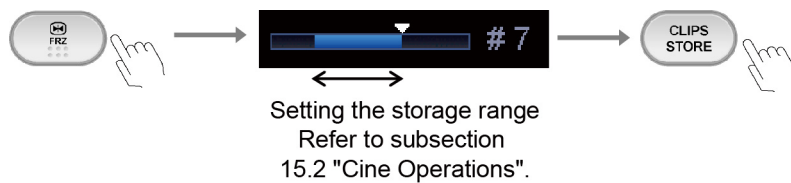

- NOTE:**
1.  is displayed at the bottom of the monitor while the data is being stored on the HDD. Panel operation is disabled during this period.
  2. When the number of cardiac cycles is specified as the image storing period but the R wave is not detected, the image is stored for the period (seconds) corresponding to the specified number of cardiac cycles.
  3. The image save time for Clips defines the hard limit beyond which image saving is not possible. However, for certain types of images, the actual maximum time may be less than this value.
  4. When R-R is selected as the method for specifying the image storing range, a heart rate of 50 bpm or higher is assumed. If the patient's heart rate is less than 50 bpm, the image may not be stored for the specified number of cardiac cycles.
  5. Frame missing error in recording with the Clips function  

If the system detects that image frames are missing, the error message below is displayed and the images are not recorded. Release freeze status and acquire the image again.

**[Failed in storing data, some frames were missed. Please try again.]**
  6. When the volume of stored data with raw data exceeds approximately 300 MB during retrospective storage, one of the following messages is displayed.
    - (a) When the HDD is set as the recording destination
 

Less than 500 MB:	<b>[Large Raw Data. Storing will take 20 seconds or more.]</b>
Less than 700 MB:	<b>[Large Raw Data. Storing will take 30 seconds or more.]</b>
Less than 1024 MB:	<b>[Large Raw Data. Storing will take 40 seconds or more.]</b>
1024 MB or more:	<b>[Large Raw Data. Storing will take 50 seconds or more.]</b>
    - (b) When a location other than the HDD is set as the recording destination
 

Less than 500 MB:	<b>[Data will be stored to HDD only. Please send to your destination later. Large Raw Data. Storing will take 20 seconds or more.]</b>
Less than 700 MB:	<b>[Data will be stored to HDD only. Please send to your destination later. Large Raw Data. Storing will take 30 seconds or more.]</b>
Less than 1024 MB:	<b>[Data will be stored to HDD only. Please send to your destination later. Large Raw Data. Storing will take 40 seconds or more.]</b>
1024 MB or more:	<b>[Data will be stored to HDD only. Please send to your destination later. Large Raw Data. Storing will take 50 seconds or more.]</b>
  7. In prospective mode, the data is stored at the specified destination regardless of the volume of data.
  8. The Still Store operation and print operation are disabled during image storage in prospective mode.

### 19.2.4 Setting of the storage format (for retrospective storage)

The dynamic image storage format can be preset using the system preset menu.  
(Refer to subsection 22.2.1 of the operation manual Applications volume for details.)

## 19.3 File Handling for Image Data

The image data acquired using this system is in DICOM format as the standard.  
The Patient Browser is provided for file handling of DICOM format image data.  
Refer to the operation manual Applications volume for details.

## 19.4 Displaying Saved Images

Use Exam Review to display the saved images.

Exam Review displays the images that are saved on the HDD, provided that the patient information for these images has been entered in the patient information registration screen.

It also displays the previous images selected using the Patient Browser (by pressing the **[View]** switch). Refer to the operation manual Applications volume for details.

**NOTE:** Do not display data in this system that has been imported from other devices, except for data used for the Fusion function (option).

Data imported from other devices may not be displayed properly.

# 20. Maintenance

## 20.1 Technical Descriptions

For technical descriptions about this system, refer to the following manuals.

- Installation manual
- Maintenance manual
- Disposal manual

## 20.2 Outline of Preventive Maintenance

Daily checks, periodic inspection, and replacement of consumable parts/periodically replaced parts are included in preventive maintenance. For replacement of periodically replaced parts, special techniques are required because special tools are used or there are special risks involved.

TOSHIBA provides preventive maintenance services requiring special techniques on a pay-for-service basis.

TOSHIBA requests that the user sign a preventive maintenance contract to arrange for periodic inspection and cleaning by TOSHIBA service personnel in order to ensure reliable system operation.

If you have any questions concerning preventive maintenance or preventive maintenance contracts, contact your TOSHIBA service representative.

**⚠ CAUTION:**

- 1. If preventive maintenance is performed by the user, special care must be taken to ensure safety.**
- 2. If any abnormality of the system is found during inspection, stop using the system and contact your TOSHIBA service representative for repair.**

**NOTE:** The following message is displayed in the information display area when the period of operation (time) set for the system has elapsed (factory setting: 600 hours). When this message is displayed, it is recommended that the user submit a request for inspection by a service engineer. The interval for display of this message can be changed. Contact your TOSHIBA service representative.

 System inspection is recommended. A long time has passed since last system inspection.

## 20.3 Preventive Maintenance Performed by the User

### 20.3.1 Cleaning the system

- ⚠ CAUTION:**
1. Before cleaning the system, be sure to disconnect the system power cable from the outlet of the facility. If the system is defective, an electric shock may occur.
  2. Do not spill or spray liquids such as water onto the system or peripheral units. If a liquid such as water enters the system or peripheral units, an electric shock may occur.

**CAUTION:** Do not use solvents (such as paint thinner, benzene, or alcohol) or abrasive cleansers to clean the system. These substances may cause deterioration or discoloration of the system.

#### 1 Cleaning the transducer

---



Clean, disinfect, and sterilize the transducer referring to the operation manual provided with the transducer.

#### 2 Cleaning the transducer holder and gel holder

---



- (a) Wipe off any stains on the transducer holder and gel holder using a soft, dry cloth.
  - (b) If it is difficult to remove stains, wipe them off using a soft cloth moistened with mild detergent.
-



### 3 Cleaning the reference signal cable

---

- CAUTION:**
1. Do not allow the clips to become wet. The ECG tracing will not be displayed correctly.
  2. Do not immerse the connector in water. Wipe the connector with a dry cloth only. If moisture enters the connector, the system may fail.

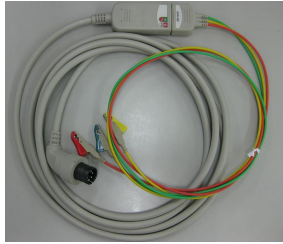

Clean the reference signal cable regularly.

- (a) Wipe off any stains using a soft cloth moistened with mild detergent and then tightly wrung out.
- (b) Wipe the reference signal cable with a dry cloth and let it dry completely.

### 4 Cleaning the monitor

---

- CAUTION:**
1. Do not hit or apply excessive force to the LCD screen during cleaning. Doing so may damage the monitor.
  2. Never use a stiff or hard cloth to clean the monitor. Doing so may damage the monitor cover or LCD screen.
  3. Do not allow liquid droplets to remain on the LCD screen. The droplets may cause small stains when they dry or may enter the LCD screen, possibly resulting in failure.



- (a) Monitor cover
  - Clean the monitor cover using a soft cloth moistened with mild detergent.
- (b) LCD screen
  - Use a soft cotton cloth or lens cleaning paper to clean the LCD screen.
  - If stains on the LCD screen are difficult to remove, wipe it gently with a soft cloth slightly moistened with water and then wipe it with a soft, dry cloth.

**5** Cleaning the surface of the touch panel

---



- (a) Clean the surface of the touch panel using a commercially available eyeglass cleaning cloth (non-woven rayon cloth etc.).
- (b) If necessary, use a piece of soft cloth moistened with water or neutral detergent and then tightly wrung out.

**6** Cleaning the system, main panel, and transducer connector

---



- (a) Wipe the system using a soft cloth moistened with mild detergent.
  - (b) Clean around the switches or keys on the main panel using cotton buds.
  - (c) Wipe the transducer connector with a soft, dry cloth. If it is difficult to remove all the stains with a dry cloth, use a soft cloth moistened with water.
-

## 7 Cleaning the trackball

---

- (a) Turn the ring on the trackball case in the direction indicated by the arrow to remove the dial.

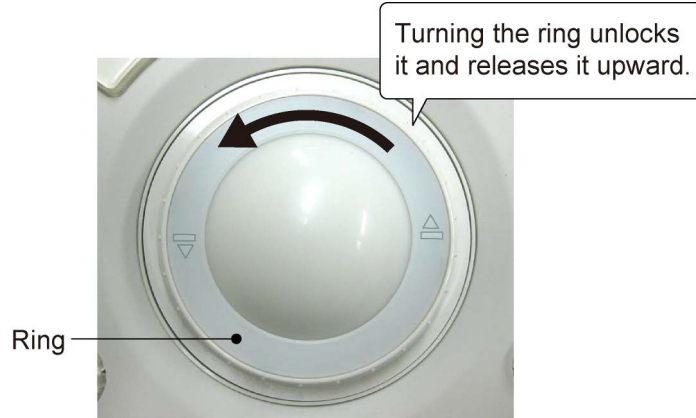

**CAUTION:** To prevent malfunction, be careful when removing the dial.

- (b) Remove the ball carefully and place it in a cardboard box or other suitable container to prevent it from dropping.
- (c) Clean the ball and ball bearings, being sure to remove all dirt and foreign matter.

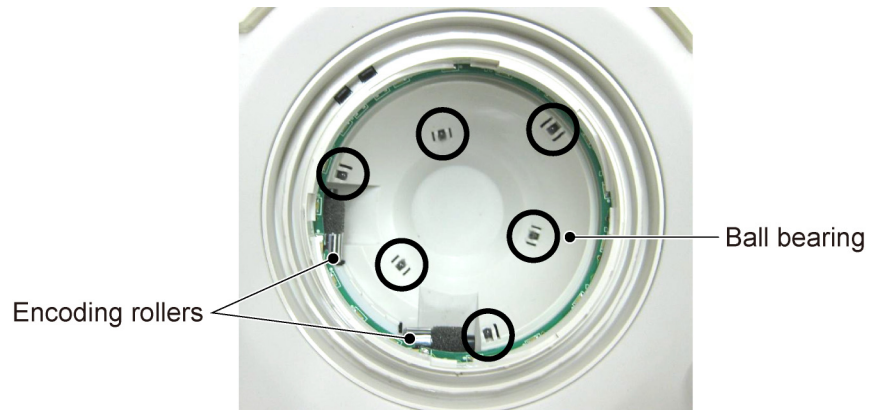

**CAUTION:** Do not touch the encoding rollers.

If foreign matter has adhered to the encoding rollers, contact your TOSHIBA service representative.

---

- (d) Lightly place the ball in the trackball assembly, and then place the dial over it.

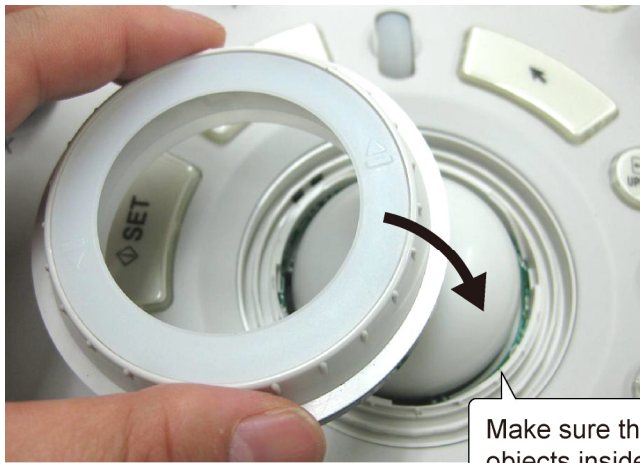

Make sure that there are no foreign objects inside the trackball assembly.

- (e) The arrows on the dial should be in the position shown below.

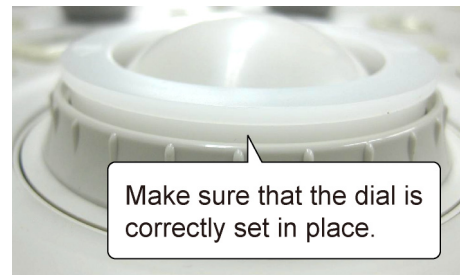

Make sure that the dial is correctly set in place.

**CAUTION:** Set the dial so that it is properly seated. If the ring is locked with the dial not properly seated, the palm switch may be damaged.

- (f) Turn the ring in the direction shown to tighten it.

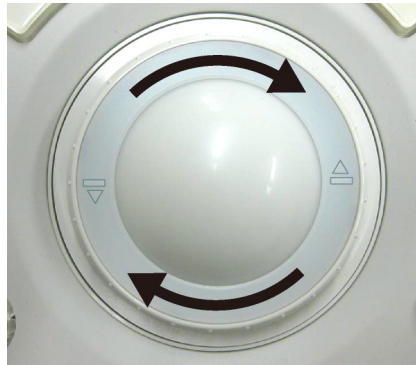

- (g) After the trackball is assembled, confirm the following:
- The ball and dial operate smoothly, there is no abnormal sound, and the ball is not loose.
  - The trackball works normally after the power is turned ON.

## 8 Cleaning the air filters

---

Check and clean the air filters to prevent overheating of the system or a reduction in system performance/reliability due to clogging of the filters.

**CAUTION:** Do not boot up the system while the air filters are removed. The system may malfunction.

- (a) Remove the air filters (3 locations).



- (b) Remove all dust from the filters using a vacuum cleaner at a location away from the system.
- (c) Remount the air filters.
-

### 20.3.2 Disinfecting the system

This subsection describes the procedures and precautions for disinfecting the system.

For disinfection of transducers, refer to the operation manuals provided with the transducers.

**⚠ DANGER:** After disinfecting the system, ventilate the room fully before turning the system ON.  
If flammable and explosive gas remains near or in the system, it may cause a fire or explosion.

**⚠ WARNING:**

1. Before disinfecting the system, be sure to disconnect the system power cable plug from the outlet of the facility.  
If the system is defective, an electric shock may occur.
2. Do not spill or spray liquids such as water onto the system or peripheral units. If a liquid such as water enters the system or peripheral units, an electric shock may occur.

**⚠ CAUTION:**

1. Observe the following precautions to prevent infection.
  - Wear sterile protective gloves.
  - Wear new sterile protective gloves each time disinfection is performed.
2. Do not disinfect the system using a method or chemical other than those specified in this manual. The system may not be disinfected properly, or the surface of the system may deteriorate or become discolored.
3. After chemical disinfection, dry the surface of the system fully.
4. The efficacy of the disinfectants is not guaranteed by TOSHIBA. Contact the manufacturer of the relevant chemical for the efficacy of each disinfection agent.
5. Determine the effectiveness of the chemical based on the criteria (effective period, number of times of use, discoloration of the chemical, results of testing using effectiveness test kits, etc.) described in the documentation provided by the manufacturer of the chemical.

**CAUTION:**

1. When chemical disinfections are repeated, the surface of the system is changed gradually.
2. If any abnormality related to functions of the product is observed after disinfection, stop using the product and contact your TOSHIBA service representative for repair.

## 1 Chemicals permitted for use

---

The chemicals described below are permitted for use. For detailed handling methods, refer to the documentation provided by the manufacturer of the chemical.

- Quaternary ammonium compound (0.75%): Cleanisept® wipes
- Sodium hypochlorite (0.65%) : Dispatch® Hospital Cleaner or Clorox Healthcare™ Bleach Germicidal Cleaner
- Isopropyl alcohol 70%
- Ethanol 78%

## 2 Area that can be disinfected

---

The entire system can be disinfected. However, the following parts cannot be disinfected. Clean these parts using neutral detergent as required.

- Screen of the LCD monitor
- Casters
- Footswitch
- Peripheral devices (printer, etc.)  
Refer to the documentation provided with the peripheral devices.
- Cables

## 3 Procedures for disinfecting

---

Perform the disinfection work according to the instructions by someone with a professional knowledge of disinfection.

- (a) Turn the system power OFF, and disconnect the power cable plug from the outlet of the facility.
  - (b) Wear protective gloves to prevent infection. Wear new sterile protective gloves each time disinfection is performed.
  - (c) Moisten a piece of soft cloth with a chemical, squeeze it lightly, and wipe the surface of the unit. Pay careful attention not to allow a chemical liquid to enter the unit.
  - (d) After chemical disinfection, dry the surface of the system fully.  
  
Do not heat the unit to dry it.
  - (e) Confirm that the disinfected parts are not damaged or deformed.
  - (f) After disinfecting the system, ventilate the room fully before turning the system ON.
-

### 20.3.3 Creating a backup copy of the system hard disk

As a precaution against deterioration or loss of data stored on the system hard disk, create a backup copy of the hard disk at appropriate intervals. Refer to subsection 20.3.5 "Backing up the customer-specific data (Backup)" for the detailed procedures.

### 20.3.4 [Maintenance] menu

This system is provided with a **[Maintenance]** menu that supports maintenance and management by the user. Use this **[Maintenance]** menu as required.

**CAUTION:** Do not use the **[Maintenance]** menu during an examination. The **[Maintenance]** menu must be opened before a patient ID is registered after system power ON or after an examination is terminated by pressing  in the **[Patient Registration]** menu.

Submenu name	Function
<b>[Backup]</b>	Backup of the HDD data to external storage media can be performed to protect customer-specific data or to transfer such data to another system.



## 20.3.5 Backing up the customer-specific data (Backup)

<<Displaying the [Backup] menu>>

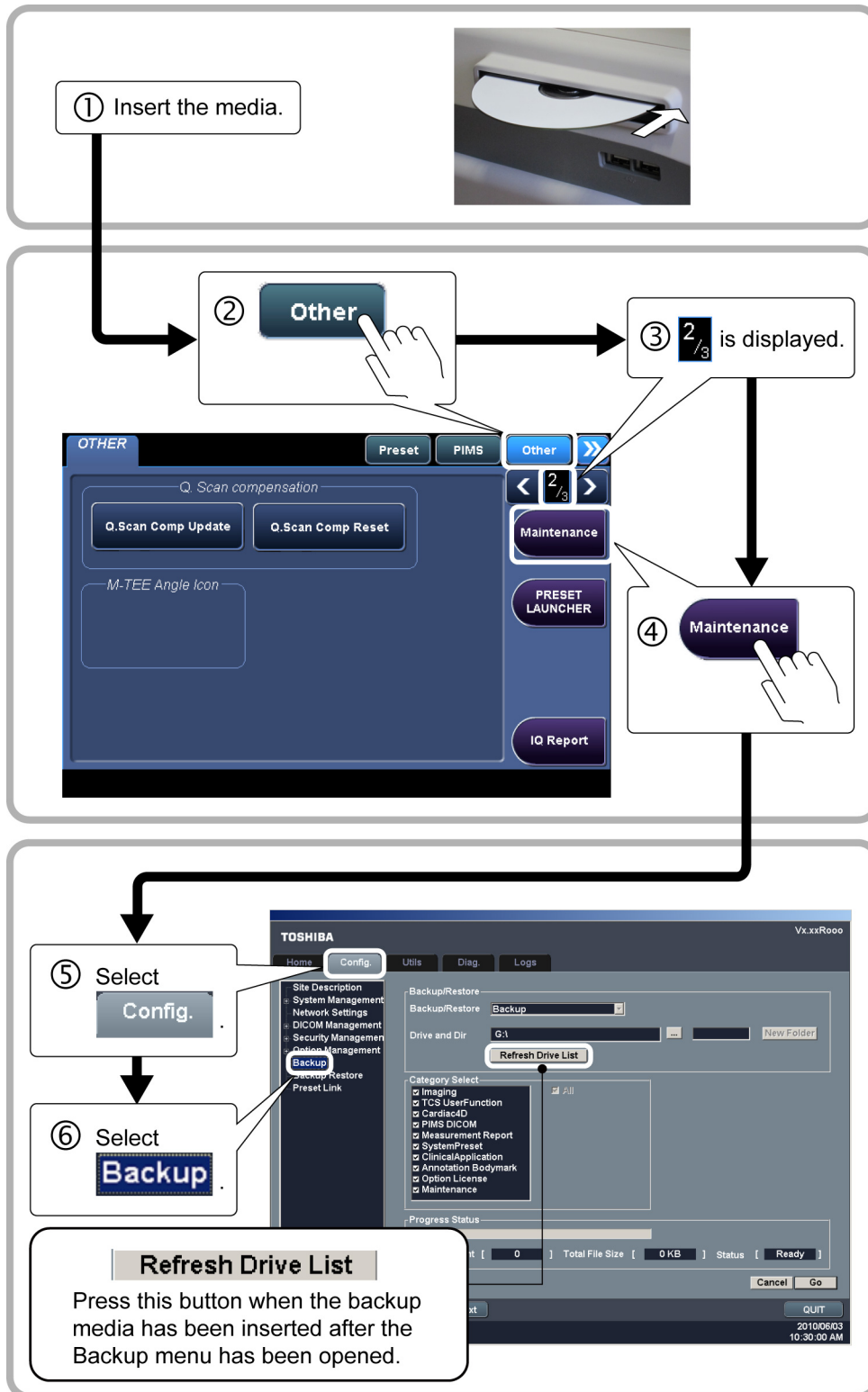

**CAUTION:** Do not remove the backup media from the drive while the media is being accessed.

<<Steps>>

The image shows two screenshots of the Toshiba backup software interface. The top screenshot shows the main backup configuration window with a 'New Folder' button highlighted. A callout box with the number 1 points to this button. A text box on the right explains the steps: 1. Enter the folder name. 2. Press the button. 3. Select 'Go'. A callout box with the number 2 points to the 'New Folder' button. A callout box with the number 3 points to the 'Go' button. A callout box with the number 4 points to the 'Go' button in the bottom right corner of the main window. The bottom screenshot shows a 'Browse for Folder' dialog box with 'G:' selected. A callout box with the number 2 points to 'G:'. A callout box with the number 3 points to the 'Ok' button. Arrows connect the callouts between the two screenshots to show the flow of the process.

How to add a new folder:

- 1 Enter the folder name.
- 2 Press the button.
- 3 Select **Go**.

① Select **...**.

② Select **New Folder**.

③ Select **Ok**.

④ Select **Go**.

**NOTE:** When backup is completed, a new folder named according to the current time is created. All the files are backed up in this folder, with the folder structure remaining as before.

<<Error Case>>

- (1) If the folder mentioned above is in use by another system, no operation is performed.
- (2) About error messages

During the backup process, the following error messages may be displayed.

Error message	Cause
<b>[Special characters in folder name. Please Change]</b>	Special characters have been entered in the folder name.
<b>[BurnDirect operation failed for destination CD]</b>	There is not enough capacity in the backup media.
<b>[BurnDirect operation failed for destination CD]</b>	CD-R/DVD is not inserted in the drive.
<b>[BurnDirect operation failed for destination CD]</b>	CD-R/DVD in the drive is in use.

**NOTE:** The following special characters cannot be used in a folder name.

"\", "/", ":", "\*", "?", "<", ">", "|"

## 20.4 Preventive Maintenance Performed by Service Personnel

To ensure safety and maintain optimal system performance, the following checks must be performed by service personnel with the required training and expertise. Contact your TOSHIBA service representative.

Check contents	Check items	Check interval
Cleaning	Transducer, transducer holder Main body, peripheral units Air filters	1 year
Electrical safety	Protective conductor resistance Leakage current Patient auxiliary current	1 year
Mechanical safety	Caster/monitor/panel operations, mounting sections Peripheral units Appearance of the transducer	1 year
Checking/recording images	Images in each mode Images acquired using a standard transducer	1 year

## 20.5 Periodically Replaced Parts and Consumable Parts

The parts used in this equipment have a long service life. However, to maintain the safety, specifications, and performance of the system, periodic replacement of some parts (batteries for system power backup etc.) is required (replacement interval: 1 year). Special techniques are required for replacement of periodically replaced parts. Contact your TOSHIBA service representative.

Note that the power cable, casters, and the magnetic sensor securing adapter (an accessory of the Function unit) are consumable parts.

## 20.6 Checks During Storage

Perform preventive maintenance during storage of the system.

# 21. Disposal

To meet environmental standards, the components inside the system need to be classified and disposed of. As the system contains heavy components, precautions must be followed when they are disassembled.

When disposal of the system is required, contact your TOSHIBA service representative.

**⚠WARNING:** This system and its parts should be disposed of as industrial waste material. When disposing of them, all applicable laws and regulations must be observed and a certified waste disposal contractor must handle the disposal work.

**⚠CAUTION:** Be sure to delete all data stored on disks and other media before disposal to ensure that personal information is not disclosed.

## 22. Checks Before the System Is Judged Defective

If no images are displayed while the power is ON, characters are displayed but no images are displayed, or other abnormalities are observed, check the items listed below before determining that the system is defective.

Problems	What to do
The system cannot be turned ON.	<ul style="list-style-type: none"> <li>• Confirm that the power plug is connected to the outlet correctly.</li> <li>• Check the main power switch on the power panel.</li> </ul>
The system can be turned ON, but no images are displayed.	<ul style="list-style-type: none"> <li>• Adjust the contrast and brightness controls on the monitor.</li> <li>• Check whether the equipment is in external video signal input mode.</li> </ul>
<p>The system goes OFF spontaneously while in use.</p> <p>The system reboots spontaneously while in use.</p>	<ul style="list-style-type: none"> <li>• Check whether a power outage has occurred.</li> <li>• Check whether the power plug is connected properly.</li> </ul>
Characters are displayed but no images are displayed.	<ul style="list-style-type: none"> <li>• Confirm that the <b>[ACOUSTIC POWER]</b> dial, <b>[GAIN]</b> dial, and STC slide controls are set to their maximum positions. If images are still not displayed, confirm that the transducer is connected to the transducer connector correctly or use a different transducer.</li> </ul>
An error dialog (error message) is displayed and the operation is disabled.	<ul style="list-style-type: none"> <li>• Turn the power of the system OFF and then ON referring to section 9 "Turning the Power ON/OFF".</li> </ul>

**CAUTION:**

1. Do not disconnect the power plug while the system is starting up. Doing so may cause the system to malfunction.
2. If either of the following phenomena occurs, press and hold down  for 5 seconds or more to turn OFF the power of the system.
  - The startup screen is not displayed after waiting for 30 seconds.
  - The patient registration screen is not displayed after waiting for 10 minutes.

If the power is not turned ON after holding down  for 5 seconds or more, turn OFF the main power on the power panel. Do not turn OFF the power in this manner during normal operation. Doing so may cause the system to malfunction.
3. If the main power switch on the power panel or circuit protector has tripped, be sure to contact your TOSHIBA service representative. If the main power switch is turned ON again without identifying and correcting the problem, the system or other devices may be damaged.

- NOTE:**
1. Some time is required before an ultrasound image is displayed on the monitor after the power is turned ON. The time differs depending on the system conditions, but typically is within 3 minutes.
  2. The power shutdown process may take approximately 1.5 to 3 minutes depending on the system conditions.
  3. After the main power has been turned OFF on the power panel, wait for at least 15 seconds before turning the power ON again.  
If the main power switch is turned ON immediately after the power has been turned OFF, the system may malfunction.
  4. If the power of the system is turned OFF suddenly by a power outage etc., the LED on the side of the system may flash.  
In this case, turn OFF the main power switch on the power panel.  
Before turning ON the power again, confirm that the LED is not lit.



<If the main breaker is on the side of the system>



LEDs

<If the main breaker is on the rear of the system>



LEDs

If the system cannot be turned ON, the problem is not corrected, or the system operates abnormally after the above items have been checked, contact your TOSHIBA service representative.

# 23. Specifications

## 23.1 External Dimensions and Mass

Item	Specifications
External dimensions (not including optional units)	580 ±20 mm (width) × 1390 ±30 mm to 1790 ±50 mm (height) × 890 ±30 mm to 1010 ±30 mm (depth)
Mass (not including optional units)	Approximately 145 kg

## 23.2 Essential Performance of This System

Functions described in sections 11, 14, 15, and 18, and measurement function



## 23.3 Conformance Standards

- Canada
  - (1) General : CAN/CSA-C22.2 No. 601.1-M90  
IEC 60601-1 Ed. 3 (2005)
  - (2) Collateral : IEC 60601-1-2 (2007)
  - (3) Particular : IEC 60601-2-37 (2001), Amd. 1 (2004), Amd. 2 (2005)  
IEC 60601-2-37 Ed. 2 (2007)
  
- EU and other regions requiring compliance with European Directive 93/42/EEC and subsequent amendments
  - (1) General : EN 60601-1 (2006)
  - (2) Collateral : EN 60601-1-2 (2007)
  - (3) Particular : EN 60601-2-37 (2008)
  
- USA
  - (1) General : IEC 60601-1 (1988), Amd. 1 (1991), Amd. 2 (1995)  
UL 60601-1(2003) R6.03
  - (2) Collateral : IEC 60601-1-1 (2000)  
IEC 60601-1-2 (2001), Amd. 1 (2004)  
IEC 60601-1-4 (1996), Amd. 1 (1999)
  - (3) Particular : IEC 60601-2-37 (2001), Amd. 1 (2004), Amd. 2 (2005)
  
- Other Regions
  - (1) General : IEC 60601-1 (1988), Amd. 1 (1991), Amd. 2 (1995)
  - (2) Collateral : IEC 60601-1-1 (2000)  
IEC 60601-1-2 (2001), Amd. 1 (2004)  
IEC 60601-1-4 (1996), Amd. 1 (1999)
  - (3) Particular : IEC 60601-2-37 (2001), Amd. 1 (2004), Amd. 2 (2005)

## 23.4 Safety Classification

This system is classified with respect to safety characteristics.

(1) According to the type of protection against electric shock:

- CLASS I

(2) According to the degree of protection against electric shock:

- EQUIPMENT WITH TYPE-BF APPLIED PARTS (reference signal cable)
- EQUIPMENT WITH TYPE-B APPLIED PARTS (PCG, pulse)

(3) According to the degree of protection against harmful ingress of water:

- IPX0 (enclosed EQUIPMENT without protection against ingress of water)

However, the footswitch is IPX8.

(4) According to the degree of safety of application in the presence of FLAMMABLE ANAESTHETIC MIXTURE WITH AIR or WITH OXYGEN OR NITROUS OXIDE:

- EQUIPMENT not suitable for use in the presence of a FLAMMABLE ANAESTHETIC MIXTURE WITH AIR or WITH OXYGEN OR NITROUS OXIDE

(5) According to the mode of operation:

- CONTINUOUS OPERATION

## 23.5 Accuracy of Measurement

### Accuracy of Each Clinical Measurement Parameter

Parameter	Ranges	Accuracy
- Image Depth Scale	Up to 400 mm	< ±5% or < 1 mm, if below 20 mm
- Physio/Image Scales	Up to 10 s	< ±3%
- Distance/Depth	Up to 400 mm	< ±5% or < 1 mm, if below 20 mm
- Area	Up to 999 cm <sup>2</sup>	< ±10% or < 0.41 cm <sup>2</sup> , if below 4 cm <sup>2</sup>
- Circumference	Up to 1800 mm	< ±5% or < 1 mm, if below 20 mm
- Angle	0 to 180°	< ±1°
- Volume	Up to 4200 cm <sup>3</sup>	< ±16% or < 1.3 cm <sup>3</sup> , if below 8 cm <sup>3</sup>
- Velocity	Up to 2000 cm/s	< ±5% of the full scale
- Time	Up to 10 s	< ±3% of the full scale
- Heart Rate	20 to 300 bpm	< ±3%
- Accel	Up to 20000 cm/s <sup>2</sup>	< ±8%
- M distance	Up to 280 mm	< ±5% or < 1 mm, if below 20 mm
- Slope	Up to 1000 mm/s	< ±8%

### Range of Applicability of the Accuracy Specifications

These measurements will satisfy the accuracies stated above over the entire selected field of view. The accuracy stated is either the measured value or the calculated value for worst case conditions.

It should be noted, however, that the above values are not guaranteed for measurements performed on stored images that use manual calibration or MPR images that have been created based on data acquired using the 4D transducer. For details of manual calibration, refer to the operation manual Measurements volume. For details of the 4D transducer, refer to the section describing the 4D function in the operation manual Applications volume.

# 24. Using MI/TI

## 24.1 Using MI/TI (Outside the USA and Canada)

### 24.1.1 Basic knowledge of MI/TI

(1) Concerns with bioeffects

Studies have revealed that ultrasound with extremely high intensity is harmful to body tissues. This rapid advance has generated concerns about the potential risk of bioeffects when new applications or diagnostic technologies become available.

(2) Mechanical effects and thermal effects

Studies have revealed that two different kinds of ultrasound characteristics affect human bodies: one is the mechanical effects due to cavitation generated when the negative pressure of ultrasound exceeds a certain limit, and the other is the effects due to thermal energy generated when tissues absorb ultrasound. The levels of these two kinds of effects are represented by indices: the MI (Mechanical Index) and the TI (Thermal Index), respectively.

(3) MI/TI values

The smaller the MI/TI values, the less the bioeffects.

(4) Controlling the ultrasound output

In 1976, the FDA in the USA established limits to the acoustic output level for diagnostic ultrasound equipment (TRACK1), along with the rapid advance in diagnostic ultrasound technology, and the versatile proliferation of its applications, in order to ensure the safety of patients. Thereinafter, manufacturers were required to control the acoustic output level below the limits, when releasing new diagnostic ultrasound systems on the market.

**NOTE:**  $I_{spta,3}$  may be represented as  $I_{zpta,\alpha}$  ( $\alpha = 0.3\text{dB/cm/MHz}$ ) or  $I_{spta,\alpha}$  ( $\alpha = 0.3\text{dB/cm-MHz}$ ) (IEC 60601-2-37).

Maximum acoustic power specified by FDA (TRACK1)

Application	$I_{spta,3}$ (mW/cm <sup>2</sup> )	$I_{sppa,3}$ (W/cm <sup>2</sup> )	MI
Peripheral blood vessels	720	190	1.9
Cardiovascular systems	430	190	1.9
Fetal and other	94	190	1.9
Eyes	17	28	0.23

The idea of MI/TI has been introduced recently to increase the diagnostic capability, promoting relaxation of these acoustic power limits (TRACK3).

Maximum limit for MI/TI display (TRACK3)

Application	Ispta.3 (mW/cm <sup>2</sup> )	Isppa.3 (W/cm <sup>2</sup> )	MI
All regions (except eyes)	720	≤190	≤1.9

With this trend, control of the level of acoustic power has been transferred from manufacturers to users.

**⚠CAUTION:** The FDA allows ultrasound equipment to output acoustic power level TRACK3, which is higher than TRACK1, provided that MI/TI values are displayed on the system. This means that users have a higher degree of responsibility for safety than manufacturers. Against this background, users are required to understand the ultrasound bioeffects and their causes.

(5) ALARA (As Low As Reasonably Achievable)

It is required to practice ALARA when using ultrasound energy. Practicing ALARA ensures that the total energy level is controlled below a low enough level at which bioeffects are not generated while diagnostic information is being accumulated. The total energy is controlled by output intensity and total radiation time. The output intensity necessary for examinations differs depending on the patient and the clinical case.

**⚠CAUTION:** It is strictly required that acoustic output be set based on the ALARA (As Low As Reasonably Achievable) principle. However, not all examinations can be performed with an extremely low level of acoustic energy. Controlling the acoustic level at an extremely low level leads to low-quality images or insufficient Doppler signals, adversely affecting the reliability of the diagnosis. However, increasing the acoustic power more than necessary does not always contribute to an increase in quality of information required for diagnosis, rather increasing the risk of generating bioeffects. Users must take responsibility for the safety of patients and utilize ultrasound deliberately. Deliberate use of ultrasound means that output power of ultrasound must be selected based on ALARA.

## 24.1.2 MI/TI display description

### (1) Definition of MI

**Mechanical Index (MI)** is the peak-rarefactional acoustic pressure  $P_{r,\alpha}$  (calculated considering the tissue attenuation;  $\alpha = 0.3$  dB/cm/MHz) divided by the square root of the acoustic working frequency  $f_{awf}$  (unit: MHz) and can be expressed as follows:

$$MI = \frac{P_{r,\alpha}}{\sqrt{f_{awf}} \times C_{MI}},$$

where  $C_{MI} = 1$  (MPa /  $\sqrt{\text{MHz}}$ )

### (2) Definition of TI

**Thermal Index (TI)** is the ratio of total acoustic power to the acoustic power required to raise tissue temperature by 1 degree centigrade under defined assumptions.

**TIS (Thermal Index Soft Tissue)** is related to heating in abdominal, cardiac and peripheral vascular applications.

**TIB (Thermal Index Bone)** is related to bone heating, which may be of particular importance in fetal applications.

**TIC (Thermal Index Cranial)** is related to heating in adult cephalic applications.

### (3) Displayed MI/TI values

#### **Accuracy**

The MI and TI values are determined and displayed based on the measured acoustic power data. The displayed values contain errors due to the following factors.

- \* Measurement error in acoustic power measurement
- \* Variation in the characteristics of the system and transducer
- \* Ultrasound propagation characteristics

**Display Precision** is rounded in units of 0.1.

The MI and TI values are displayed only when the value is 0.4 or higher.

### 24.1.3 Parameters affecting the MI/TI values

The MI/TI values are affected by transmission conditions (focus, drive frequency, voltage applied to piezoelectric elements, etc.), scan conditions, and settings of the main panel, and **[Preset]** menu.

- (1) Transmission conditions
  - Transmission focal position
  - Transmission frequency
  - PRF
  - Frame rate
  - Acoustic power
- (2) Scan conditions
  - Scan width
  - Number of scanning lines
- (3) Control switches affecting MI/TI
  - (a) Switches on the main panel
    - **[2D]**
    - **[ADF]**
    - **[CDI]**
    - **[POWER]**
    - **[PW]**
    - **[CW]**
    - **[M]**
    - **[DEPTH/ZOOM]**
    - **[ACOUSTIC POWER]\***
    - **[SET]**
    - **[NEXT]**
  - (b) Switches displayed in 2D mode
    - **[2D Steer]**
    - **[ApliPure]**
    - **[Freq.]**
    - **[Focus]**
    - **[Focal Type]**
    - **[Scan Range]**
    - **[THI Type]**
    - **[Frame Rate]**
  - (c) Switches displayed in CDI, POWER, and ADF modes
    - **[Scale]**
    - **[C Freq.]**
    - **[C Focus]**
    - **[Frame Rate]**
    - **[Data No.]**
  - (d) Switches displayed in PWD mode
    - **[DOP Freq.]**
    - **[DOP Scale]**
    - **[UPDATE]**

**⚠ CAUTION:** Note that for switches other than those marked \*, the MI/TI value may change in a direction not intended for the above parameters.

**24.1.4 Operating procedures for MI/TI**

The control of ultrasound output and the most useful switches for this purpose are described below.

(1) **[ACOUSTIC POWER]** knob

The output intensity is one of the available ultrasound output control parameters. It can be adjusted with the **[ACOUSTIC POWER]** knob at the right end of the main panel. To decrease ultrasound output, turn the knob counterclockwise and to increase ultrasound output, turn the knob clockwise.



(2) Setting the defaults for **[ACOUSTIC POWER]**

Selection of diagnostic applications is the most important factor for controlling ultrasound output. The permissible level of intensity of ultrasound differs depending on the region of interest. For fetal examinations, in particular, much care must be exercised. For this reason, the  switch must be used to reset the parameters for each new patient, and the **[Preset]** menu must be used to select the settings appropriate for each new region of interest.

In this system, imaging presets can be created using the ultrasound output set by the user. At this time, the default function is disabled. Any changes to the default setting value are the responsibility of the user.

Default choices

Initial power	0% to 100%*
---------------	-------------

\* Definition of 100%:  
 The maximum acoustic power of a transducer determined by the increase in transducer surface temperature in the selected mode and the acoustic power restrictions specified by the FDA.

\* Any value less than 1% is displayed as 0.XX%.



(3) Default setting for acoustic power

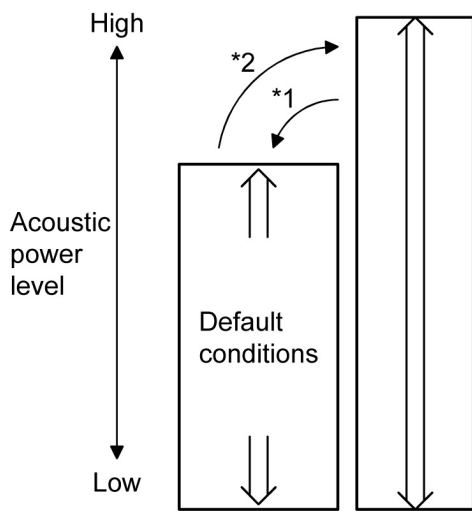

**NOTE:** This system automatically returns to the preset default values whenever changes are made to the (\*1) POWER ON, TRANSDUCER connector selection, NEW PATIENT, or PRESET values in the application menu. In the default status, the acoustic output power is limited below preset values. Following the ALARA restrictions, the user is allowed to increase the acoustic power by turning the (\*2) **[ACOUSTIC POWER]** knob clockwise under Track3 limits and to save it to user definable presets.

### 24.1.5 Output display

This system displays thermal and mechanical indices in real-time. The display conforms to IEC 60601-2-37, "Particular requirements for the safety of ultrasonic medical diagnostic and monitoring equipment."

The display is intended to give the user information related to the likelihood of bioeffects from tissue/bone heating (TI) and cavitation (MI). The user should practice ALARA (As Low As Reasonably Achievable) with respect to these indices.

The maximum acoustic intensity with any transducer/system combination will remain below the FDA (Federal Food and Drug Administration) limit of  $720 \text{ mW/cm}^2$ ,  $I_{\text{spta}}$  and either  $1.9 \text{ MI}$  or  $190 \text{ W/cm}^2$ ,  $I_{\text{sppa}}$ .

For additional information on bioeffects beyond that contained in this labeling, contact your TOSHIBA service representative. As further information becomes available on the potential for bioeffects, these displays may change.

### 24.1.6 Reminder

As a reminder, **Always Practice ALARA**. The display gives information in real time and therefore shows the current acoustic exposure rates to the tissue or structure being insonated.

For inquiries and information, contact your TOSHIBA service representative. Additionally, as further information becomes available, we will do our utmost to keep you informed.

## 24.1.7 Ultrasonic output power and acoustic output

### (1) Derated Ultrasonic Output Parameters

In order to determine the relevant Ultrasonic Output Parameters, a method is used which allows for the comparison of ultrasound systems which operate at different frequencies and are focused at different depths. This approach, called "derating" or "attenuating", adjusts the acoustic output as measured in a water tank to account for the effect of ultrasound propagation through tissue. By convention, a specific average intensity attenuation value is used, which corresponds to a loss of 0.3 dB/cm/MHz. That is, the intensity of ultrasound will be reduced by 0.3 dB/MHz for every centimeter of travel from the transducer. This can be expressed by the following equation:

$$I_{atten} = I_{water} \times 10^{(-0.3/10 \times f_c \times z)}$$

Where:

$I_{atten}$  : Attenuated intensity

$I_{water}$  : Intensity measured in a water tank (at distance z)

$f_c$  : Center frequency of the ultrasound wave (as measured in water)

z : Distance from the transducer

$$P_{atten} = P_{water} \times 10^{(-0.3/20 \times f_c \times z)}$$

Where:

$P_{atten}$  : Attenuated pressure

$P_{water}$  : Pressure measured in a water tank (at distance z)

$f_c$  : Center frequency of the ultrasound wave (as measured in water)

z : Distance from the transducer

Since the intensity is proportional to the square of the pressure, the above two equations are analogous to each other.

Although the attenuation coefficient chosen, 0.3 dB/cm/MHz, is significantly lower than any specific solid tissue in the body, this value was chosen to account for fetal examinations. In early trimester ultrasound fetal examinations, there may be a significant fluid path between the transducer and the fetus, and the attenuation of fluid is very small. Therefore the attenuation coefficient was lowered to account for this case.

### (2) Acoustic Output Limits

The derating (or attenuated) approach was incorporated into the FDA Acoustic Output Limits, as listed below. The acoustic output level is designed to fall below these limits.

FDA Maximum Acoustic Output Limits for Track 3 (Attenuated Values)

Application	Ispta.3 (mW/cm <sup>2</sup> )	Isppa.3 (W/cm <sup>2</sup> )	MI
All regions (except eyes)	720	≤190	≤1.9

In addition, the TI (TIS, TIB and TIC) is designed not to exceed 6.0.

(3) Differences between displayed and "actual" Thermal and Mechanical effects

In operation, the system will display to the operator the Acoustic Output Parameters Thermal Index, TI, or Mechanical Index, MI (or sometimes both parameters simultaneously). These parameters were developed as general indicators of risk from either thermal or mechanical action of the ultrasound wave. They serve to indicate to the operator whether a particular setting of the system increases or decreases the possibility of Thermal or Mechanical effect. More specifically, they were designed to assist in the implementation of the ALARA principle (refer to subsection 24.1.6 "Reminder"). As an operator changes a given system control (refer to subsection 24.1.3 "Parameters affecting the MI/TI values"), the potential effect of the change in output will be indicated. However, the Thermal Index is not the same as temperature rise in the body, for several reasons. First of all, in order to provide a single display index to the user, a number of simplifying assumptions had to be made. The biggest assumption was the use of the attenuating formula described above, which is much lower than the actual value for most tissues within the body. Scanning through muscle or organ tissue, for example, will produce much higher attenuation than 0.3 dB/cm/MHz. There were also significant simplifications made for the thermal properties of tissue. Therefore, scanning through highly perfused tissue, such as the heart or vasculature, will produce significantly less thermal effect than that suggested by the Thermal Index.

Similarly, the Mechanical Index was derived to indicate the relative possibility of mechanical (cavitation) effects. The MI is based on the derated peak rarefactional pressure and the center frequency of the ultrasound wave (refer to subsection 24.2.2 "MI/TI display description"). The actual peak rarefactional pressure is affected by the actual attenuation caused by tissue in the path between the transducer and the focal point. Again, all solid tissues within the body have higher attenuation than the proscribed 0.3 dB/cm/MHz value, and therefore, the actual peak rarefactional pressure will be lower. Further, the actual peak rarefactional pressure will change depending upon the region of the body being scanned.

For these reasons, the TI and MI displays should only be used to assist the operator in implementing ALARA at the time of the patient examination.

### 24.1.8 References for MI/TI

For further information on measurement methods and MI/TI, refer to the followings:

- (1) "Acoustic Output Measurement Standard for Diagnostic Ultrasound Equipment, Revision 3" issued by AIUM/NEMA in 2004
- (2) "Standard for real-time display of thermal and mechanical acoustic output indices on diagnostic ultrasound equipment, Revision 2" issued by AIUM/NEMA in 2004
- (3) "Bioeffects and Safety of Diagnostic Ultrasound" issued by AIUM in 1993
- (4) "Medical Ultrasound Safety" issued by AIUM in 1994
- (5) "Information for Manufacturers Seeking Marketing Clearance of Diagnostic Ultrasound Systems and Transducers" issued by FDA in 2008
- (6) World Federation for Ultrasound in Medicine and Biology (WFUMB), *Conclusions and Recommendations on Thermal and Non-thermal Mechanisms for Biological Effects of Ultrasound*. Report of the 1996 WFUMB Symposium on Safety of Ultrasound in Medicine. Barnett, S.B. (ed). Ultrasound in Medicine and Biology, Vol 24, suppl 1, 1998.

## 24.2 Using MI/TI (in the USA and Canada)

### 24.2.1 Basic knowledge of MI/TI

(1) Concerns with bioeffects

Diagnostic ultrasound is recognized as being safe. In fact, there have been no reports of injuries to patients caused by diagnostic ultrasound. It cannot be stated categorically that ultrasound is 100% safe. Studies have revealed that ultrasound with extremely high intensity is harmful to body tissues. This rapid advance has generated concerns about the potential risk of bioeffects when new applications or diagnostic technologies become available.

(2) Mechanical effects and thermal effects

Studies have revealed that two different kinds of ultrasound characteristics affect human bodies: one is the mechanical effects due to cavitation generated when the negative pressure of ultrasound exceeds a certain limit, and the other is the effects due to thermal energy generated when tissues absorb ultrasound. The levels of these two kinds of effects are represented by indices: the MI (Mechanical Index) and the TI (Thermal Index), respectively.

(3) MI/TI values

The smaller the MI/TI values, the less the bioeffects.

(4) Controlling the ultrasound output

In 1976, the FDA in the USA established limits to the acoustic output level for diagnostic ultrasound equipment (TRACK1), along with the rapid advance in diagnostic ultrasound technology, and the versatile proliferation of its applications, in order to ensure the safety of patients. Thereinafter, manufacturers were required to control the acoustic output level below the limits, when releasing new diagnostic ultrasound systems on the market.

**NOTE:**  $I_{spta,3}$  may be represented as  $I_{zpta,\alpha}$  ( $\alpha = 0.3$  dB/cm/MHz) (IEC 60601-2-37).

Maximum acoustic power specified by FDA (TRACK1)

Application	$I_{spta,3}$ (mW/cm <sup>2</sup> )	$I_{sppa,3}$ (W/cm <sup>2</sup> )	MI
Peripheral blood vessels	720	190	1.9
Cardiovascular systems	430	190	1.9
Fetal and other	94	190	1.9
Eyes	17	28	0.23

The idea of MI/TI has been introduced recently to increase the diagnostic capability, promoting relaxation of these acoustic power limits (TRACK3).

Maximum limit for MI/TI display (TRACK3)

Application	Ispta.3 (mW/cm <sup>2</sup> )	Isppa.3 (W/cm <sup>2</sup> )	MI
All regions (except eyes)	720	≤190	≤1.9

or

With this trend, control of the level of acoustic power has been transferred from manufacturers to users.

**⚠CAUTION:** The FDA allows ultrasound equipment to output acoustic power level TRACK3, which is higher than TRACK1, provided that MI/TI values are displayed on the system. This means that users have a higher degree of responsibility for safety than manufacturers. Against this background, users are required to understand the ultrasound bioeffects and their causes.

(5) ALARA (As Low As Reasonably Achievable)

It is required to practice ALARA when using ultrasound energy. Practicing ALARA ensures that the total energy level is controlled below a low enough level at which bioeffects are not generated while diagnostic information is being accumulated. The total energy is controlled by output intensity and total radiation time. The output intensity necessary for examinations differs depending on the patient and the clinical case.

**⚠CAUTION:** It is strictly required that acoustic output be set based on the ALARA (As Low As Reasonably Achievable) principle. However, not all examinations can be performed with an extremely low level of acoustic energy. Controlling the acoustic level at an extremely low level leads to low-quality images or insufficient Doppler signals, adversely affecting the reliability of the diagnosis. However, increasing the acoustic power more than necessary does not always contribute to an increase in quality of information required for diagnosis, rather increasing the risk of generating bioeffects. Users must take responsibility for the safety of patients and utilize ultrasound deliberately. Deliberate use of ultrasound means that output power of ultrasound must be selected based on ALARA.

## 24.2.2 MI/TI display description

### (1) Definition of MI

**Mechanical Index (MI)** is the peak-rarefactional acoustic pressure  $P_3$  (calculated considering the tissue attenuation) divided by the square root of the center frequency  $f_c$  (unit: MHz) and can be expressed as follows:

$$MI = \frac{P_3}{\sqrt{f_c}}$$

### (2) Definition of TI

**Thermal Index (TI)** is the ratio of total acoustic power to the acoustic power required to raise tissue temperature by 1 degree centigrade under defined assumptions.

**TIS (Thermal Index Soft Tissue)** is related to heating in abdominal, cardiac and peripheral vascular applications.

**TIB (Thermal Index Bone)** is related to bone heating, which may be of particular importance in fetal applications.

**TIC (Thermal Index Cranial)** is related to heating in adult cephalic applications.

### (3) Displayed MI/TI values

#### **Accuracy**

The MI and TI values are mean values that are determined and displayed based on the measured acoustic power data.

The displayed label names have "m" as the last character (such as MI<sub>m</sub> and TI<sub>m</sub>).

The system also has other index values. They are called global maximum values and internally control the ultrasound output. They are determined statistically, based on the variation due to the following factors.

- \* Measurement error in acoustic power measurement
- \* Variation in the characteristics of the system and transducer
- \* Ultrasound propagation characteristics

**Display Precision** is rounded in units of 0.1.

The MI and TI values are displayed only when the value is 0.4 or higher.

### 24.2.3 Parameters affecting the MI/TI values

The MI/TI values are affected by transmission conditions (focus, drive frequency, voltage applied to piezoelectric elements, etc.), scan conditions, and settings of the main panel, and **[Preset]** menu.

(1) Transmission conditions

- Transmission focal position
- Transmission frequency
- PRF
- Frame rate
- Acoustic power

(2) Scan conditions

- Scan width
- Number of scanning lines

(3) Control switches affecting MI/TI

(a) Switches on the main panel

- **[2D]**
- **[ADF]**
- **[CDI]**
- **[POWER]**
- **[PW]**
- **[CW]**
- **[M]**
- **[DEPTH/ZOOM]**
- **[ACOUSTIC POWER]\***
- **[SET]**
- **[NEXT]**

(b) Switches displayed in 2D mode

- **[2D Steer]**
- **[ApliPure]**
- **[Freq.]**
- **[Focus]**
- **[Focal Type]**
- **[Scan Range]**
- **[THI Type]**
- **[Frame Rate]**

(c) Switches displayed in CDI, POWER, and ADF modes

- **[Scale]**
- **[C Freq.]**
- **[C Focus]**
- **[Frame Rate]**
- **[Data No.]**

(d) Switches displayed in PWD mode

- **[DOP Freq.]**
- **[DOP Scale]**
- **[UPDATE]**

**⚠ CAUTION:** Note that for switches other than those marked \*, the MI/TI value may change in a direction not intended for the above parameters.

**24.2.4 Operating procedures for MI/TI**

The control of ultrasound output and the most useful switches for this purpose are described below.

(1) **[ACOUSTIC POWER]** knob

The output intensity is one of the available ultrasound output control parameters. It can be adjusted with the **[ACOUSTIC POWER]** knob at the right end of the main panel. To decrease ultrasound output, turn the knob counterclockwise and to increase ultrasound output, turn the knob clockwise.



(2) Setting the defaults for **[ACOUSTIC POWER]**

Selection of diagnostic applications is the most important factor for controlling ultrasound output. The permissible level of intensity of ultrasound differs depending on the region of interest. For fetal examinations, in particular, much care must be exercised. For this reason, the  switch must be used to reset the parameters for each new patient, and the **[Preset]** menu must be used to select the settings appropriate for each new region of interest.

In this system, imaging presets can be created using the ultrasound output set by the user. At this time, the default function is disabled. Any changes to the default setting value are the responsibility of the user.

Default choices

Initial power	0% to 100%*
---------------	-------------

- \* Definition of 100%:  
The maximum acoustic power of a transducer determined by the increase in transducer surface temperature in the selected mode and the acoustic power restrictions specified by the FDA.
- \* Any value less than 1% is displayed as 0.XX%.



(3) Default setting for acoustic power

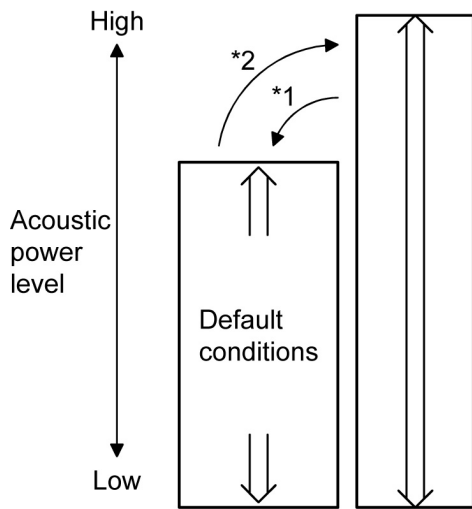

**NOTE:** This system automatically returns to the preset default values whenever changes are made to the (\*1) POWER ON, TRANSDUCER connector selection, NEW PATIENT, or PRESET values in the application menu. In the default status, the acoustic output power is limited below preset values. Following the ALARA restrictions, the user is allowed to increase the acoustic power by turning the (\*2) **[ACOUSTIC POWER]** knob clockwise under Track3 limits and to save it to user definable presets.

### 24.2.5 Output display

This system displays thermal and mechanical indices in real-time. The display conforms to the "Standard for Real-Time Display of Thermal and Mechanical Output Indices on Diagnostic Ultrasound Equipment", which is the voluntary standard of AIUM (American Institute of Ultrasound in Medicine) and NEMA (National Electrical Manufacturers Association).

The display is intended to give the user information related to the likelihood of bioeffects from tissue/bone heating (TI) and cavitation (MI). The user should practice ALARA (As Low As Reasonably Achievable) with respect to these indices.

The absolute maximum acoustic intensity with any transducer/system combination will remain below the FDA (Federal Food and Drug Administration) limit of  $720 \text{ mW/cm}^2$ ,  $I_{\text{spta}}$  and either  $1.9 \text{ MI}$  or  $190 \text{ W/cm}^2$ ,  $I_{\text{sppa}}$ .

For additional information on bioeffects beyond that contained in this labeling, contact your TOSHIBA service representative. As further information becomes available on the potential for bioeffects, these displays may change.

Information from AIUM is included in the operational information for MI and TI. You are strongly encouraged to become familiar with this information and to understand the potential for bioeffects. Always practice ALARA and avoid unnecessary use of ultrasound.

### 24.2.6 Information contained in the system documentation

Information from AIUM and FDA is included in the system documentation. This information details the basics of ultrasound, the mechanical and thermal indices, their clinical and biological meaning, and information on the ALARA principal.

The included information is extremely important for the understanding and use of the system. It will help yield effective diagnostic images while keeping acoustic exposure as low as possible. You are strongly encouraged to read this information.

The information following this section describes the operational controls which affect the MI/TI values and the acoustic exposure to the patient. These controls should be understood by the user and their effects should be observed prior to the performance of examinations.

### 24.2.7 Measurement uncertainty and precision

The total estimated measurement uncertainty (where the total uncertainty includes the uncertainties in hydrophone response, measurement, calculation, and positioning) are:

	<u>Expanded uncertainty</u>
$I_{spta}$	19.8%
$I_{sppa}$	19.8%
Center frequency ( $f_c$ )	1.9%
Total power (W)	6.2%
Rarefactional pressure (pr)	9.8%
	(k=2.132, C.I.=90%)

### 24.2.8 Reminder

As a reminder, **Always Practice ALARA**. The display gives information in real time and therefore shows the current acoustic exposure rates to the tissue or structure being insonated.

For inquiries and information, contact your TOSHIBA service representative. Additionally, as further information becomes available, we will do our utmost to keep you informed.

## 24.2.9 Ultrasonic output power and acoustic output

### (1) Derated Ultrasonic Output Parameters

In order to determine the relevant Ultrasonic Output Parameters, a method is used which allows for the comparison of ultrasound systems which operate at different frequencies and are focused at different depths. This approach, called "derating" or "attenuating", adjusts the acoustic output as measured in a water tank to account for the effect of ultrasound propagation through tissue. By convention, a specific average intensity attenuation value is used, which corresponds to a loss of 0.3 dB/cm/MHz. That is, the intensity of ultrasound will be reduced by 0.3 dB/MHz for every centimeter of travel from the transducer. This can be expressed by the following equation:

$$I_{\text{atten}} = I_{\text{water}} \times 10^{(-0.3/10 \times f_c \times z)}$$

Where:

$I_{\text{atten}}$  : Attenuated intensity

$I_{\text{water}}$  : Intensity measured in a water tank (at distance z)

$f_c$  : Center frequency of the ultrasound wave (as measured in water)

z : Distance from the transducer

$$P_{\text{atten}} = P_{\text{water}} \times 10^{(-0.3/20 \times f_c \times z)}$$

Where:

$P_{\text{atten}}$  : Attenuated pressure

$P_{\text{water}}$  : Pressure measured in a water tank (at distance z)

$f_c$  : Center frequency of the ultrasound wave (as measured in water)

z : Distance from the transducer

Since the intensity is proportional to the square of the pressure, the above two equations are analogous to each other.

Although the attenuation coefficient chosen, 0.3 dB/cm/MHz, is significantly lower than any specific solid tissue in the body, this value was chosen to account for fetal examinations. In early trimester ultrasound fetal examinations, there may be a significant fluid path between the transducer and the fetus, and the attenuation of fluid is very small. Therefore the attenuation coefficient was lowered to account for this case.

### (2) Acoustic Output Limits

The derating (or attenuated) approach was incorporated into the FDA Acoustic Output Limits, as listed below. The acoustic output level is designed to fall below these limits.

FDA Maximum Acoustic Output Limits for Track 3 (Attenuated Values)

Application	Ispta.3 (mW/cm <sup>2</sup> )	Isppa.3 (W/cm <sup>2</sup> )	or	MI
All regions (except eyes)	720	≤190		≤1.9

In addition, the TI (TIS, TIB and TIC) is designed not to exceed 6.0.

(3) Differences between displayed and "actual" Thermal and Mechanical effects

In operation, the system will display to the operator the Acoustic Output Parameters Thermal Index, TI, or Mechanical Index, MI (or sometimes both parameters simultaneously). These parameters were developed as general indicators of risk from either thermal or mechanical action of the ultrasound wave. They serve to indicate to the operator whether a particular setting of the system increases or decreases the possibility of Thermal or Mechanical effect. More specifically, they were designed to assist in the implementation of the ALARA principle (refer to subsection 24.2.8 "Reminder"). As an operator changes a given system control (refer to subsection 24.2.3 "Parameters affecting the MI/TI values"), the potential effect of the change in output will be indicated. However, the Thermal Index is not the same as temperature rise in the body, for several reasons. First of all, in order to provide a single display index to the user, a number of simplifying assumptions had to be made. The biggest assumption was the use of the attenuating formula described above, which is much lower than the actual value for most tissues within the body. Scanning through muscle or organ tissue, for example, will produce much higher attenuation than 0.3 dB/cm/MHz. There were also significant simplifications made for the thermal properties of tissue. Therefore, scanning through highly perfused tissue, such as the heart or vasculature, will produce significantly less thermal effect than that suggested by the Thermal Index.

Similarly, the Mechanical Index was derived to indicate the relative possibility of mechanical (cavitation) effects. The MI is based on the derated peak rarefactional pressure and the center frequency of the ultrasound wave (refer to subsection 24.2.2 "MI/TI display description"). The actual peak rarefactional pressure is affected by the actual attenuation caused by tissue in the path between the transducer and the focal point. Again, all solid tissues within the body have higher attenuation than the proscribed 0.3 dB/cm/MHz value, and therefore, the actual peak rarefactional pressure will be lower. Further, the actual peak rarefactional pressure will change depending upon the region of the body being scanned.

For these reasons, the TI and MI displays should only be used to assist the operator in implementing ALARA at the time of the patient examination.

### 24.2.10 References for MI/TI

For further information on measurement methods and MI/TI, refer to the followings:

- (1) "Acoustic Output Measurement Standard for Diagnostic Ultrasound Equipment, Revision 3" issued by AIUM/NEMA in 2004
- (2) "Standard for real-time display of thermal and mechanical acoustic output indices on diagnostic ultrasound equipment, Revision 2" issued by AIUM/NEMA in 2004
- (3) "Bioeffects and Safety of Diagnostic Ultrasound" issued by AIUM in 1993
- (4) "Medical Ultrasound Safety" issued by AIUM in 1994
- (5) "Information for Manufacturers Seeking Marketing Clearance of Diagnostic Ultrasound Systems and Transducers" issued by FDA in 2008
- (6) "Guide to the expression of uncertainty in measurement" issued by ISO in 1995
- (7) World Federation for Ultrasound in Medicine and Biology (WFUMB), *Conclusions and Recommendations on Thermal and Non-thermal Mechanisms for Biological Effects of Ultrasound*. Report of the 1996 WFUMB Symposium on Safety of Ultrasound in Medicine. Barnett, S.B. (ed). Ultrasound in Medicine and Biology, Vol 24, suppl 1, 1998.

# 25. Guidance and Manufacturer's Declaration

This product is compliant with the following EMC standards.

- On systems complying with European Directive 93/42/EEC  
IEC 60601-1-2:2007
- Other systems  
IEC 60601-1-2 (2001), Amd.1 (2004)

(1) Guidance and manufacture's declaration

<b>Guidance and manufacturer's declaration - electromagnetic emissions</b>		
This system is intended for use in the electromagnetic environment specified below. The customer or the user of this system should assure that it is used in such an environment.		
Emissions test	Compliance	Electromagnetic environment - guidance
RF emissions CISPR 11	Group 1	This system uses RF energy only for its internal function. Therefore, its RF emissions are very low and are not likely to cause any interference in nearby electronic equipment.
RF emissions CISPR 11	Class B	This system is suitable for use in all establishments, including domestic establishments and those directly connected to the public low-voltage power supply network that supplies buildings used for domestic purposes.
Harmonic emissions IEC 61000-3-2	Class A*	
Voltage fluctuations/ flicker emissions IEC 61000-3-3	Complies*	*: Not applicable to the regions classified as Other 1 (where a line voltage of 110 to 120 VAC is used).

NOTE: Do not use cables or parts other than those intended for this product.  
If cables or parts other than those intended for this product are used, performance related to electromagnetic emission may deteriorate.

### Guidance and manufacturer's declaration - electromagnetic immunity

This system is intended for use in the electromagnetic environment specified below. The customer or the user of this system should assure that it is used in such an environment.

Immunity test	IEC 60601 test level	Compliance level	Electromagnetic environment - guidance
Electrostatic discharge (ESD) IEC 61000-4-2	±6 kV contact ±8 kV air	±6 kV contact ±8 kV air	Floors should be wood, concrete or ceramic tile. If floors are covered with synthetic material, the relative humidity should be at least 30%.
Electrical fast transient/burst IEC 61000-4-4	±2 kV for power supply lines ±1 kV for input/output lines	±2 kV for power supply lines ±1 kV for input/output lines	Mains power quality should be that of a typical commercial or hospital environment.
Surge IEC 61000-4-5	±1 kV differential mode ±2 kV common mode	±1 kV differential mode ±2 kV common mode	Mains power quality should be that of a typical commercial or hospital environment.
Voltage dips, short interruptions and voltage variations on power supply input lines IEC 61000-4-11	<5 % $UT$ (>95 % dip in $UT$ ) for 0,5 cycle 40 % $UT$ (60 % dip in $UT$ ) for 5 cycles 70 % $UT$ (30 % dip in $UT$ ) for 25 cycles <5 % $UT$ (>95 % dip in $UT$ ) for 5 s	<5 % $UT$ (>95 % dip in $UT$ ) for 0.5 cycle 40 % $UT$ (60 % dip in $UT$ ) for 5 cycles 70 % $UT$ (30 % dip in $UT$ ) for 25 cycles <5 % $UT$ (>95 % dip in $UT$ ) for 5 s	Mains power quality should be that of a typical commercial or hospital environment. If the user of this system requires continued operation during power mains interruptions, it is recommended for this system to be powered from an uninterruptible power supply.
Power frequency (50/60 Hz) magnetic field IEC 61000-4-8	3 A/m	3 A/m	Power frequency magnetic fields should be at levels characteristic of a typical location in a typical commercial or hospital environment.

NOTE 1:  $UT$  is the a.c. mains voltage prior to application of the test level.

NOTE 2: Do not use cables or parts other than those intended for this product. If cables or parts other than those intended for this product are used, performance related to electromagnetic immunity may deteriorate.

## Guidance and manufacturer's declaration - electromagnetic immunity

This system is intended for use in the electromagnetic environment specified below. The customer or the user of this system should assure that it is used in such an environment.

Immunity test	IEC 60601 test level	Compliance level	Electromagnetic environment - guidance
<p>Conducted RF IEC 61000-4-6</p> <p>Radiated RF IEC 61000-4-3</p>	<p>3 Vrms 150 kHz to 80 MHz</p> <p>3 V/m 80 MHz to 2.5 GHz</p>	<p>3 Vrms</p> <p>3 V/m</p>	<p>Portable and mobile RF communications equipment should be used no closer to any part of this system, including cables, than the recommended separation distance calculated from the equation applicable to the frequency of the transmitter.</p> <p><b>Recommended separation distance</b></p> <p><math>d = 1.2\sqrt{P}</math> 150 kHz to 80 MHz</p> <p><math>d = 1.2\sqrt{P}</math> 80 MHz to 800 MHz</p> <p><math>d = 2.3\sqrt{P}</math> 800 MHz to 2.5 GHz</p> <p>where <math>P</math> is the maximum output power rating of the transmitter in watts (<math>W</math>) according to the transmitter manufacturer and <math>d</math> is the recommended separation distance in meters (<math>m</math>). Field strengths from fixed RF transmitters, as determined by an electromagnetic site survey,<sup>a</sup> should be less than the compliance level in each frequency range.<sup>b</sup></p> <p>Interference may occur in the vicinity of equipment marked with the following symbol:</p> <div style="text-align: center;">  </div>

NOTE 1: At 80 MHz and 800 MHz, the higher frequency range applies.

NOTE 2: These guidelines may not apply in all situations. Electromagnetic propagation is affected by absorption and reflection from structures, objects and people.

NOTE 3: Do not use cables or parts other than those intended for this product. If cables or parts other than those intended for this product are used, performance related to electromagnetic immunity may deteriorate.

<sup>a</sup> Field strengths from fixed transmitters, such as base stations for radio (cellular/cordless) telephones and land mobile radios, amateur radio, AM and FM radio broadcast and TV broadcast cannot be predicted theoretically with accuracy. To assess the electromagnetic environment due to fixed RF transmitters, an electromagnetic site survey should be considered. If the measured field strength in the location in which this system is used exceeds the applicable RF compliance level above, this system should be observed to verify normal operation. If abnormal performance is observed, additional measures may be necessary, such as re-orienting or relocating this system.

<sup>b</sup> Over the frequency range 150 kHz to 80 MHz, field strengths should be less than 3 V/m.



**Recommended separation distances between portable  
and mobile RF communications equipment and the system**

This system is intended for use in an electromagnetic environment in which radiated RF disturbances are controlled. The customer or the user of this system can help prevent electromagnetic interference by maintaining a minimum distance between portable and mobile RF communications equipment (transmitters) and this system as recommended below, according to the maximum output power of the communications equipment.

Rated maximum output power of transmitter W	Separation distance according to frequency of transmitter m		
	150 kHz to 80 MHz $d = 1.2\sqrt{P}$	80 MHz to 800 MHz $d = 1.2\sqrt{P}$	800 MHz to 2.5 GHz $d = 2.3\sqrt{P}$
0.01	0.12	0.12	0.23
0.1	0.38	0.38	0.73
1	1.2	1.2	2.3
10	3.8	3.8	7.3
100	12	12	23

For transmitters rated at a maximum output power not listed above, the recommended separation distance  $d$  in meters (m) can be estimated using the equation applicable to the frequency of the transmitter, where  $P$  is the maximum output power rating of the transmitter in watts (W) according to the transmitter manufacturer.

NOTE 1: At 80 MHz and 800 MHz, the separation distance for the higher frequency range applies.

NOTE 2: These guidelines may not apply in all situations. Electromagnetic propagation is affected by absorption and reflection from structures, objects and people.

NOTE 3: Do not use cables or parts other than those intended for this product. If cables or parts other than those intended for this product are used, performance related to recommended separation distances may deteriorate.

# 26. Intellectual Property

## 26.1 Availability of This Software and Related Documents Is Restricted.

The software used for this system includes software owned by Toshiba Medical Systems Corporation and licensed to Toshiba Medical Systems Corporation by a Licensor.

- (1) The software and related documents must be used only for this system.
- (2) The intellectual property of this software and related documents is not assigned to you.
- (3) You must not copy the software or documents, nor modify the software in whole or in part.
- (4) You must not recompile or reassemble the software.
- (5) You must not assign, disclose, transfer, or sublicense the software or documents to a third party.
- (6) The software is subject to the U.S. and Japanese Export Administration Laws and Regulations and you must not export or re-export the software in whole or in part unless properly authorized by the U.S. or Japanese government.
- (7) The information in the documents, or programs in the software are subject to change without notice.
- (8) The licensor shall have no liability for any express or implied warranties or any indirect, incidental, special, punitive, or consequential damages related to the software and related documents.

## 26.2 Agreement for Microsoft Software

Read the end-user license agreement for Microsoft software on the following pages.

- Windows 7

## **MICROSOFT SOFTWARE LICENSE TERMS**

### **WINDOWS 7 ULTIMATE FOR EMBEDDED SYSTEMS**

### **WINDOWS 7 PROFESSIONAL FOR EMBEDDED SYSTEMS (ALL VERSIONS)**

---

These license terms are an agreement between you and Toshiba Medical Systems Corporation. Please read them. They apply to the software included on this device. The software also includes any separate media on which you received the software.

The software on this device includes software licensed from Microsoft Corporation or its affiliate.

The terms also apply to any Microsoft

- updates,
- supplements,
- Internet-based services, and
- support services

for this software, unless other terms accompany those items. If so, those terms apply.

If you obtain updates or supplements directly from Microsoft, then Microsoft, and not Toshiba Medical Systems Corporation, licenses those to you.

**As described below, using the software also operates as your consent to the transmission of certain computer information for Internet-based services.**

**By using the software, you accept these terms. If you do not accept them, do not use the software. Instead, contact Toshiba Medical Systems Corporation to determine its return policy for a refund or credit.**

---

**If you comply with these license terms, you have the rights below.**

#### **1. OVERVIEW.**

- Software.** The software includes desktop operating system software. This software does not include Windows Live services. Windows Live services are available from Microsoft under a separate agreement.

#### **2. USE RIGHTS.**

- Use.** The software license is permanently assigned to the device with which you acquired the software. That device is the "licensed device". You may use the software on the licensed device.
- Processor Limit.** You may use the software with no more than two processors at any one time.
- Alternative Versions.** You may only use the version of the software that is installed on the licensed device. You may not change it to any other version (such as the 32-bit or 64-bit version, or another language version).

#### **3. ADDITIONAL LICENSING REQUIREMENTS AND/OR USE RIGHTS.**

- Specific Use.** Toshiba Medical Systems Corporation designed the licensed device for a specific use. You may only use the software for that use.
- Other Software.** You may use other programs with the software as long as the other programs
  - directly support the specific use for the licensed device, or
  - provide system utilities, resource management, or anti-virus or similar protection.

Software that provides consumer or business tasks or processes may not run on the licensed device. This includes email, word processing, spreadsheet, database, scheduling and personal finance software. The licensed device may use terminal services protocols to access such software running on a server.

- c. **Device Connections.** You may not use the software as server software. In other words, more than one device may not access, display, run, share or use the software at the same time. You may allow up to twenty other devices to access the software to use
- File Services,
  - Print Services,
  - Internet Information Services, and
  - Internet Connection Sharing and Telephony Services.

The twenty connection limit applies to devices that access the software indirectly through “multiplexing” or other software or hardware that pools connections. You may use unlimited inbound connections at any time via TCP/IP.

- d. **Remote Access Technologies.** You may access and use the software remotely from another device using remote access technologies as follows.

Remote Desktop. The single primary user of the licensed device may access a session from any other device using Remote Desktop or similar technologies. A “session” means the experience of interacting with the software, directly or indirectly, through any combination of input, output and display peripherals. Other users may access a session from any device using these technologies, if the remote device is separately licensed to run the software.

Other Access Technologies. You may use Remote Assistance or similar technologies to share an active session.

Other Remote Uses. You may allow any number of devices to access the software for purposes other than those described in the Device Connections and Remote Access Technologies sections above, such as to synchronize data between devices.

- e. **Font Components.** While the software is running, you may use its fonts to display and print content. You may only
- embed fonts in content as permitted by the embedding restrictions in the fonts; and
  - temporarily download them to a printer or other output device to print content.
- f. **Icons, images and sounds.** While the software is running, you may use but not share its icons, images, sounds, and media.

4. **POTENTIALLY UNWANTED SOFTWARE.** The software includes Windows Defender. If Windows Defender is turned on, it will search this device for “spyware,” “adware” and other potentially unwanted software. If it finds potentially unwanted software, the software will ask you if you want to ignore, disable (quarantine) or remove it. Any potentially unwanted software rated “high” or “severe,” will be automatically removed after scanning unless you change the default setting. Removing or disabling potentially unwanted software may result in
- other software on your computer ceasing to work, or
  - your breaching a license to use other software on this device.

By using this software, it is possible that you will also remove or disable software that is not potentially unwanted software.

5. **SCOPE OF LICENSE.** The software is licensed, not sold. This agreement only gives you some rights to use the software. Toshiba Medical Systems Corporation and Microsoft reserve all other rights. Unless applicable law gives you more rights despite this limitation, you may use the software only as expressly permitted in this agreement. In doing so, you must comply with any technical limitations in the software that allow you to use it only in certain ways. For more information, see the software documentation or contact Toshiba Medical Systems Corporation. You may not:
- work around any technical limitations in the software;

- reverse engineer, decompile or disassemble the software;
- make more copies of the software than specified in this agreement;
- publish the software for others to copy;
- rent, lease or lend the software; or
- use the software for commercial software hosting services.

Except as expressly provided in this agreement, rights to access the software on this device do not give you any right to implement Microsoft patents or other Microsoft intellectual property in software or devices that access this device.

- **INTERNET-BASED SERVICES.** Microsoft provides Internet-based services with the software. Microsoft may change or cancel them at any time.
- a. **Consent for Internet-Based Services.** The licensed device may contain one or more of the software features described below. These features connect to Microsoft or service provider computer systems over the Internet. In some cases, you will not receive a separate notice when they connect. For more information about these features, visit

[go.microsoft.com/fwlink/?linkid=104604](http://go.microsoft.com/fwlink/?linkid=104604).

**By using these features, you consent to the transmission of this information.** Microsoft does not use the information to identify or contact you.

Computer Information. The following features use Internet protocols, which send to the appropriate systems computer information, such as your Internet protocol address, the type of operating system and browser, and the name and version of the software you are using. Microsoft uses this information to make the Internet-based services available to you. Toshiba Medical Systems Corporation has elected to turn on the following features in the licensed device.

- Plug and Play and Plug and Play Extensions. You may connect new hardware to your device. Your device may not have the drivers needed to communicate with that hardware. If so, the update feature of the software can obtain the correct driver from Microsoft and install it on your device.
- Web Content Features. Features in the software can retrieve related content from Microsoft and provide it to you. Examples of these features are clip art, templates, online training, online assistance and Appshelp. You may choose not to use these web content features.
- Digital Certificates. The software uses x.509 version 3 digital certificates. These digital certificates confirm the identity of users sending information to each other and allow you to encrypt the information. The software retrieves certificates and updates certificate revocation lists over the Internet.
- Auto Root Update. The Auto Root Update feature updates the list of trusted certificate authorities. You can switch off this feature.
- Windows Media Digital Rights Management. Content owners use Windows Media digital rights management technology (WMDRM) to protect their intellectual property, including copyrights. This software and third party software use WMDRM to play and copy WMDRM-protected content. If the software fails to protect the content, content owners may ask Microsoft to revoke the software's ability to use WMDRM to play or copy protected content. Revocation does not affect other content. When you download licenses for protected content, you agree that Microsoft may include a revocation list with the licenses. Content owners may require you to upgrade WMDRM to access their content. Microsoft software that includes WMDRM will ask for your consent prior to the upgrade. If you decline an upgrade, you will not be able to access content that requires the upgrade. You may switch off WMDRM features that access the Internet. When these features are off, you can still play content for which you have a valid license.

- Windows Media Player. When you use Windows Media Player, it checks with Microsoft for
  - compatible online music services in your region;
  - new versions of the player; and
  - codecs if your device does not have the correct ones for playing content.

For more information, go to: [go.microsoft.com/fwlink/?linkid=104605](http://go.microsoft.com/fwlink/?linkid=104605).

- Malicious Software Removal/Clean On Upgrade. Before installation of the software, the software will check and remove certain malicious software listed at [www.support.microsoft.com/?kbid=890830](http://www.support.microsoft.com/?kbid=890830) ("Malware") from your device. When the software checks your device for Malware, a report will be sent to Microsoft about any Malware detected or errors that occurred while the software was checking for Malware. No information that can be used to identify you is included in the report.
- Network Awareness. This feature determines whether a system is connected to a network by either passive monitoring of network traffic or active DNS or HTTP queries. The query only transfers standard TCP/IP or DNS information for routing purposes. You can switch off the active query feature through a registry setting.
- Windows Time Service. This service synchronizes with [www.time.windows.com](http://www.time.windows.com) once a week to provide your computer with the correct time. The connection uses standard NTP protocol.

- b. **Use of Information.** Microsoft may use the computer information, error reports, and Malware reports to improve our software and services. We may also share it with others, such as hardware and software vendors. They may use the information to improve how their products run with Microsoft software.
- c. **Misuse of Internet-based Services.** You may not use these services in any way that could harm them or impair anyone else's use of them. You may not use the services to try to gain unauthorized access to any service, data, account or network by any means.

## 6. VALIDATION.

- a. Validation verifies that the software has been activated and is properly licensed. It also verifies that no unauthorized changes have been made to the validation, licensing, or activation functions of the software. Validation may also check for certain malicious or unauthorized software related to such unauthorized changes. A validation check confirming that you are properly licensed, permits you to continue to use the software, certain features of the software or to obtain additional benefits. **You are not permitted to circumvent validation.** This is to prevent unlicensed use of the software. For more information, see [go.microsoft.com/fwlink/?Linkid=104610](http://go.microsoft.com/fwlink/?Linkid=104610).
- b. The software will from time to time perform a validation check of the software. The check may be initiated by the software or Microsoft. To enable the activation function and validation checks, the software may from time to time require updates or additional downloads of the validation, licensing or activation functions of the software. The updates or downloads are required for the proper functioning of the software and may be downloaded and installed without further notice to you. During or after a validation check, the software may send information about the software, the computer and the results of the validation check to Microsoft. This information includes, for example, the version and product key of the software, any unauthorized changes made to the validation, licensing or activation functions of the software, any related malicious or unauthorized software found and the Internet protocol address of the computer. Microsoft does not use the information to identify or contact you. By using the software, you consent to the transmission of this information. For more information about validation and what is sent during or after a validation check, see [go.microsoft.com/fwlink/?Linkid=104611](http://go.microsoft.com/fwlink/?Linkid=104611).

- c. If, after a validation check, the software is found to be counterfeit, improperly licensed, or a non-genuine Windows product, or if it includes unauthorized changes, then the functionality and experience of using the software will be affected. For example:

Microsoft may

- repair the software, and remove, quarantine or disable any unauthorized changes that may interfere with the proper use of the software, including circumvention of the activation or validation functions of the software; or
- check and remove malicious or unauthorized software known to be related to such unauthorized changes; or
- provide notice that the software is improperly licensed or a non-genuine Windows product;  
and you may
- receive reminders to obtain a properly licensed copy of the software; or
- need to follow Microsoft's instructions to be licensed to use the software and reactivate;  
and you may not be able to
- use or continue to use the software or some of the features of the software; or
- obtain certain updates or upgrades from Microsoft.

- d. You may only obtain updates or upgrades for the software from Microsoft or authorized sources (including Toshiba Medical Systems Corporation). For more information on obtaining updates from authorized sources see [go.microsoft.com/fwlink/?Linkid=104612](http://go.microsoft.com/fwlink/?Linkid=104612).

7. **PRODUCT SUPPORT.** Contact Toshiba Medical Systems Corporation for support options. Refer to the support number provided with the device.
8. **MICROSOFT .NET BENCHMARK TESTING.** The software includes one or more components of the .NET Framework (“ .NET Components”). You may conduct internal benchmark testing of those components. You may disclose the results of any benchmark test of those components, provided that you comply with the conditions set forth at [go.microsoft.com/fwlink/?LinkID=66406](http://go.microsoft.com/fwlink/?LinkID=66406).

Notwithstanding any other agreement you may have with Microsoft, if you disclose such benchmark test results, Microsoft shall have the right to disclose the results of benchmark tests it conducts of your products that compete with the applicable .NET Component, provided it complies with the same conditions set forth at [go.microsoft.com/fwlink/?LinkID=66406](http://go.microsoft.com/fwlink/?LinkID=66406).

9. **BACKUP COPY.** You may make one backup copy of the software. You may use it only to reinstall the software on the device.
10. **DOCUMENTATION.** Any person that has valid access to your computer or internal network may copy and use the documentation for your internal, reference purposes.
11. **UPGRADES.** To use upgrade software, you must first be licensed for the software that is eligible for the upgrade. Upon upgrade, this agreement takes the place of the agreement for the software you upgraded from. After you upgrade, you may no longer use the software you upgraded from.
12. **PROOF OF LICENSE.** If you acquired the software on the device, or on a disc or other media, a genuine Certificate of Authenticity label with a genuine copy of the software identifies licensed software. To be valid, this label must be affixed to the device, or included on or in Toshiba Medical Systems Corporation's software packaging. If you receive the label separately, it is not valid. You should keep the label on the device or packaging to prove that you are licensed to use the software. To identify genuine Microsoft software, see <http://www.howtotell.com>.
13. **TRANSFER TO A THIRD PARTY.** You may transfer the software only with the device, the Certificate of Authenticity label, and these license terms directly to a third party. Before the

transfer, that party must agree that these license terms apply to the transfer and use of the software. You may not retain any copies of the software including the backup copy.

- 14. NOTICE ABOUT THE H.264/AVC VISUAL STANDARD, THE VC-1 VIDEO STANDARD, THE MPEG-4 VISUAL STANDARD AND THE MPEG-2 VIDEO STANDARD.** This software may include H.264/AVC, VC-1, MPEG-4 Part 2, and MPEG-2 visual compression technology. If the software includes those visual compression technologies MPEG LA, L.L.C. requires this notice:

THIS PRODUCT IS LICENSED UNDER ONE OR MORE VIDEO PATENT PORTFOLIO LICENSES SUCH AS, AND WITHOUT LIMITATION, THE AVC, THE VC-1, THE MPEG-4 PART 2 VISUAL, AND THE MPEG-2 VIDEO PATENT PORTFOLIO LICENSES FOR THE PERSONAL AND NON-COMMERCIAL USE OF A CONSUMER TO (i) ENCODE VIDEO IN COMPLIANCE WITH THE ABOVE STANDARDS ("VIDEO STANDARDS") AND/OR (ii) DECODE VIDEO THAT WAS ENCODED BY A CONSUMER ENGAGED IN A PERSONAL AND NON-COMMERCIAL ACTIVITY OR WAS OBTAINED FROM A VIDEO PROVIDER LICENSED TO PROVIDE VIDEO UNDER SUCH PATENT PORTFOLIO LICENSES. NONE OF THE LICENSES EXTEND TO ANY OTHER PRODUCT REGARDLESS OF WHETHER SUCH PRODUCT IS INCLUDED WITH THIS PRODUCT IN A SINGLE ARTICLE. NO LICENSE IS GRANTED OR SHALL BE IMPLIED FOR ANY OTHER USE. ADDITIONAL INFORMATION MAY BE OBTAINED FROM MPEG LA, L.L.C. SEE [WWW.MPEGLA.COM](http://WWW.MPEGLA.COM).

- 15. NOT FAULT TOLERANT.** The software is not fault tolerant. Toshiba Medical Systems Corporation installed the software on the device and is responsible for how it operates on the device.
- 16. RESTRICTED USE.** The Microsoft software was designed for systems that do not require fail-safe performance. You may not use the Microsoft software in any device or system in which a malfunction of the software would result in foreseeable risk of injury or death to any person. This includes operation of nuclear facilities, aircraft navigation or communication systems and air traffic control.
- 17. THIRD PARTY PROGRAMS.** The software contains third party programs. The license terms with those programs apply to your use of them.
- 18. NO WARRANTIES FOR THE SOFTWARE.** The software is provided "as is". You bear all risks of using it. Microsoft gives no express warranties, guarantees or conditions. Any warranties you receive regarding the device or the software do not originate from, and are not binding on, Microsoft or its affiliates. When allowed by your local laws, Toshiba Medical Systems Corporation and Microsoft exclude implied warranties of merchantability, fitness for a particular purpose and non-infringement.
- 19. LIABILITY LIMITATIONS.** You can recover from Microsoft and its affiliates only direct damages up to two hundred fifty U.S. Dollars (U.S. \$250.00), or equivalent in local currency. You cannot recover any other damages, including consequential, lost profits, special, indirect or incidental damages.

This limitation applies to:

- anything related to the software, services, content (including code) on third party internet sites, or third party programs, and
- claims for breach of contract, breach of warranty, guarantee or condition, strict liability, negligence, or other tort to the extent permitted by applicable law.

It also applies even if Microsoft should have been aware of the possibility of the damages. The above limitation may not apply to you because your country may not allow the exclusion or limitation of incidental, consequential or other damages.

- 20. EXPORT RESTRICTIONS.** The software is subject to United States export laws and regulations. You must comply with all domestic and international export laws and regulations that apply to the software. These laws include restrictions on destinations, end users and end use. For additional information, see [www.microsoft.com/exporting](http://www.microsoft.com/exporting).



**21. ENTIRE AGREEMENT.** This agreement, additional terms (including any printed-paper license terms that accompany the software and may modify or replace some or all of these terms), and the terms for supplements, updates, Internet-based services and support services that you use, are the entire agreement for the software and support services.

**22. APPLICABLE LAW.**

- a. United States.** If you acquired the software in the United States, Washington state law governs the interpretation of this agreement and applies to claims for breach of it, regardless of conflict of laws principles. The laws of the state where you live govern all other claims, including claims under state consumer protection laws, unfair competition laws, and in tort.
- b. Outside the United States.** If you acquired the software in any other country, the laws of that country apply.

[20110706]

## 26.3 Others

### Patents

This product is licensed under the MPEG-4 visual patent portfolio license for the personal and non-commercial use of a consumer for (i) encoding video in compliance with the MPEG-4 visual standard ("MPEG-4 VIDEO") and/or (ii) decoding MPEG-4 video that was encoded by a consumer engaged in a personal and non-commercial activity and/or was obtained from a video provider licensed by MPEG-LA to provide MPEG-4 video. No license is granted or shall be implied for any other use. Additional information including that relating to promotional, internal and commercial uses and licensing may be obtained from MPEG LA, LLC. See <http://www.mpegla.com>.

### END USER LICENSE AGREEMENT PROVISIONS

The PIC Code may be made available by LICENSEE to third parties only pursuant to an end user license agreement. Each end user license agreement shall, at a minimum, contain terms that:

- a. Prohibit the end user to disassembly, decompile or reverse engineer the Integrated Products;
- b. Reserve to LICENSEE and PIC all rights, title and interest in and to the Integrated Products;
- c. Restrict transfer of the Integrated Product only to third parties who agree to be bound by the terms of the end user license agreement, and prohibit lending, leasing, sublicensing or pledging of the Integrated Products by end user;
- d. Include a statement substantially similar to the following:  
"Product(s) provided under this Agreement contain portions of program code owned and copyrighted by Pegasus Imaging Corporation, Tampa, Florida, support@jpg.com© 2003, ALL RIGHTS RESERVED and provided under license to [LICENSEE] by Pegasus Imaging Corporation. [LICENSEE] has assumed responsibility for the selection of such code and its use in production of the Product(s). Pegasus Imaging Corporation DISCLAIMS ALL WARRANTIES WITH RESPECT TO THE USE OF SUCH CODE IN THE PRODUCT(S), INCLUDING (WITHOUT LIMITATION) ANY WARRANTIES OF MERCHANTABILITY OR FITNESS FOR A PARTICULAR PURPOSE. In no event shall [LICENSEE] or Pegasus Imaging Corporation be liable for indirect, incidental, consequential or exemplary damages arising from use, or inability to use the Product(s), even if they knew of the possibility of such damages. Some states/countries do not allow the exclusion or limitation of liability for consequential or incidental damages so the above limitation may not apply to you."
- e. The end user license agreement and all rights to use or maintain possession of the Integrated Product shall terminate immediately upon the sublicensee's breach of any material provision of such agreement.

**Intel License Agreement  
For Open Source Computer Vision Library**

Copyright (C) 2000-2006, Intel Corporation, all rights reserved.  
Third party copyrights are property of their respective owners.

Redistribution and use in source and binary forms, with or without modification, are permitted provided that the following conditions are met:

- \* Redistribution's of source code must retain the above copyright notice, this list of conditions and the following disclaimer.
- \* Redistribution's in binary form must reproduce the above copyright notice, this list of conditions and the following disclaimer in the documentation and/or other materials provided with the distribution.
- \* The name of Intel Corporation may not be used to endorse or promote products derived from this software without specific prior written permission.

This software is provided by the copyright holders and contributors "as is" and any express or implied warranties, including, but not limited to, the implied warranties of merchantability and fitness for a particular purpose are disclaimed. In no event shall the Intel Corporation or contributors be liable for any direct, indirect, incidental, special, exemplary, or consequential damages (including, but not limited to, procurement of substitute goods or services; loss of use, data, or profits; or business interruption) however caused and on any theory of liability, whether in contract, strict liability, or tort (including negligence or otherwise) arising in any way out of the use of this software, even if advised of the possibility of such damage.

## The OpenGL Extension Wrangler Library

The OpenGL Extension Wrangler Library

Copyright (C) 2002-2007, Milan Ikits <milan ikits [] ieee org>

Copyright (C) 2002-2007, Marcelo E. Magallon <mmagallo [] debian org>

Copyright (C) 2002, Lev Povalahev

All rights reserved.

Redistribution and use in source and binary forms, with or without modification, are permitted provided that the following conditions are met:

- \* Redistributions of source code must retain the above copyright notice, this list of conditions and the following disclaimer.
- \* Redistributions in binary form must reproduce the above copyright notice, this list of conditions and the following disclaimer in the documentation and/or other materials provided with the distribution.
- \* The name of the author may be used to endorse or promote products derived from this software without specific prior written permission.

THIS SOFTWARE IS PROVIDED BY THE COPYRIGHT HOLDERS AND CONTRIBUTORS "AS IS" AND ANY EXPRESS OR IMPLIED WARRANTIES, INCLUDING, BUT NOT LIMITED TO, THE IMPLIED WARRANTIES OF MERCHANTABILITY AND FITNESS FOR A PARTICULAR PURPOSE ARE DISCLAIMED. IN NO EVENT SHALL THE COPYRIGHT OWNER OR CONTRIBUTORS BE LIABLE FOR ANY DIRECT, INDIRECT, INCIDENTAL, SPECIAL, EXEMPLARY, OR CONSEQUENTIAL DAMAGES (INCLUDING, BUT NOT LIMITED TO, PROCUREMENT OF SUBSTITUTE GOODS OR SERVICES; LOSS OF USE, DATA, OR PROFITS; OR BUSINESS INTERRUPTION) HOWEVER CAUSED AND ON ANY THEORY OF LIABILITY, WHETHER IN CONTRACT, STRICT LIABILITY, OR TORT (INCLUDING NEGLIGENCE OR OTHERWISE) ARISING IN ANY WAY OUT OF THE USE OF THIS SOFTWARE, EVEN IF ADVISED OF THE POSSIBILITY OF SUCH DAMAGE.

Mesa 3-D graphics library

Version: 7.0

Copyright (C) 1999-2007 Brian Paul All Rights Reserved.

Permission is hereby granted, free of charge, to any person obtaining a copy of this software and associated documentation files (the "Software"), to deal in the Software without restriction, including without limitation the rights to use, copy, modify, merge, publish, distribute, sublicense, and/or sell copies of the Software, and to permit persons to whom the Software is furnished to do so, subject to the following conditions:

The above copyright notice and this permission notice shall be included in all copies or substantial portions of the Software.

THE SOFTWARE IS PROVIDED "AS IS", WITHOUT WARRANTY OF ANY KIND, EXPRESS OR IMPLIED, INCLUDING BUT NOT LIMITED TO THE WARRANTIES OF MERCHANTABILITY, FITNESS FOR A PARTICULAR PURPOSE AND NONINFRINGEMENT. IN NO EVENT SHALL BRIAN PAUL BE LIABLE FOR ANY CLAIM, DAMAGES OR OTHER LIABILITY, WHETHER IN AN ACTION OF CONTRACT, TORT OR OTHERWISE, ARISING FROM, OUT OF OR IN CONNECTION WITH THE SOFTWARE OR THE USE OR OTHER DEALINGS IN THE SOFTWARE.

Copyright (c) 2007 The Khronos Group Inc.

Permission is hereby granted, free of charge, to any person obtaining a copy of this software and/or associated documentation files (the "Materials"), to deal in the Materials without restriction, including without limitation the rights to use, copy, modify, merge, publish, distribute, sublicense, and/or sell copies of the Materials, and to permit persons to whom the Materials are furnished to do so, subject to the following conditions:

The above copyright notice and this permission notice shall be included in all copies or substantial portions of the Materials.

THE MATERIALS ARE PROVIDED "AS IS", WITHOUT WARRANTY OF ANY KIND, EXPRESS OR IMPLIED, INCLUDING BUT NOT LIMITED TO THE WARRANTIES OF MERCHANTABILITY, FITNESS FOR A PARTICULAR PURPOSE AND NONINFRINGEMENT.

IN NO EVENT SHALL THE AUTHORS OR COPYRIGHT HOLDERS BE LIABLE FOR ANY CLAIM, DAMAGES OR OTHER LIABILITY, WHETHER IN AN ACTION OF CONTRACT, TORT OR OTHERWISE, ARISING FROM, OUT OF OR IN CONNECTION WITH THE MATERIALS OR THE USE OR OTHER DEALINGS IN THE MATERIALS.

## **27. Indication of Year of Manufacture**

The year of manufacture is shown on the label attached on the rear of the system.



# TOSHIBA

For Europe:

The equipment described in this manual is in accordance with the requirements of the Medical Device Directive 93/42/EEC.



Zilverstraat 1, 2718 RP  
Zoetermeer, The Netherlands

TOSHIBA MEDICAL SYSTEMS EUROPE B.V.

Unauthorized modification of the product or configuration invalidates the CE Marking.

For other countries, please contact your local distributor.

LEGAL MANUFACTURER



**TOSHIBA MEDICAL SYSTEMS CORPORATION**

1385, SHIMOISHIGAMI, OTAWARA-SHI, TOCHIGI-KEN 324-8550, JAPAN

No. 2B771-004EN\*M